

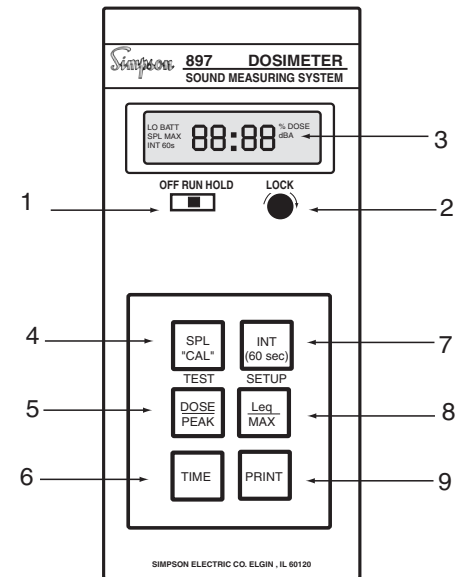

Model 897 Dosimeter Sound Measuring System OPERATOR'S MANUAL





About this Manual

To the best of our knowledge and at the time written, the information contained in this document is technically correct and the procedures accurate and adequate to operate this instrument in compliance with its original advertised specifications.

Notes and Safety Information

This Operator's Manual contains warning symbols which alert the user to check for hazardous conditions. These appear throughout this manual where applicable, and are defined below. To ensure the safety of operating performance of this instrument, these instructions must be adhered to.

 Warning, refer to accompanying documents.

 Caution, risk of electric shock.



This instrument is designed to prevent accidental shock to the operator when properly used. However, no engineering design can render safe an instrument which is used carelessly. Therefore, this manual must be read carefully and completely before making any measurements. Failure to follow directions can result in a serious or fatal accident.

Technical Assistance

SIMPSON ELECTRIC COMPANY offers assistance Monday through Friday 8:00 am to 4:30 pm Central Time. To receive assistance contact Technical Support or Customer Service at (715) 588-3311.
Internet: <http://www.simpsonelectric.com>

Warranty and Returns

SIMPSON ELECTRIC COMPANY warrants each instrument and other articles manufactured by it to be free from defects in material and workmanship under normal use and service, its obligation under this warranty being limited to making good at its factory or other article of equipment which shall within one (1) year after delivery of such instrument or other article of equipment to the original purchaser be returned intact to it, or to one of its authorized service centers, with transportation charges prepaid, and which its examination shall disclose to its satisfaction to have been thus defective; this warranty being expressly in lieu of all other warranties expressed or implied and of all other obligations or liabilities on its part, and SIMPSON ELECTRIC COMPANY neither assumes nor authorizes any other persons to assume for it any other liability in connection with the sales of its products.

This warranty shall not apply to any instrument or other article of equipment which shall have been repaired or altered outside the SIMPSON ELECTRIC COMPANY factory or authorized service centers, nor which has been subject to misuse, negligence or accident, incorrect wiring by others, or installation or use not in accord with instructions furnished by the manufacturer.

NOTES

NOTES

Contents

1.	INTRODUCTION	7
1.1	General Description	7
1.2	Items Furnished With Instrument	7
1.3	Technical Data	8
2.	PREPARATION FOR USE	11
2.1	Unpacking And Inspection	11
2.2	Preparation For Use	11
2.3	Warranty	12
2.4	Shipping	12
3.	APPLICATION	12
3.1	Decibel Scale	12
3.2	Sound Level Meter	12
3.3	Measurement And Exposure Standards	13
3.3.1	Steady Level or Slowly Varying Noise	13
3.3.2	Impact Noise	15
3.4	Dosimeter	15
3.5	Dosimeter Equation	15
3.6	Sound Fields	16
3.6.1	Free Field	16
3.6.2	Reverberant Field	16
3.7	Microphone Orientation	16
3.7.1	Area Monitor in a Free Field	16
3.7.2	Fixed Position Monitor in a Reverberant Field	16
3.7.3	Use of Dosimeter as a Personal Monitor	16
3.8	Windscreen	17
4.	OPERATION	17
4.1	Safety Precautions	17
4.2	Operating Items And Features	17
4.3	Top Panel Operating Features	19
4.4	Battery Charging	19
4.5	Preliminary Checks	20
4.5.1	Underrange Display	20
4.5.2	Overrange Display	20
4.5.3	Diagnostic Memory Test	20
4.6	Setting The Dosimeter Parameters	21
4.6.1	The Dosimeter Parameters	21
4.6.2	To Program the Dosimeter	21
4.7	Security Controls	23
4.8	Selection Of Parallel Or Serial Output Format	23
4.9	Automatic Data Logger	23
4.10	Data Output Formats	24
4.11	Parallel Output And Serial Format 2 "Prn 2"	24
4.12	Spreadsheet Output Format "Prn 1"	26
4.13	Calibration	27
4.14	Dosimeter Application	28
4.14.1	Using Microsoft Works 4.0	28
4.14.2	Using Microsoft Works 3.0 For Dos	29
4.15	Error Message	30

12. Save data or copy to another program to print.

Data will remain stored in the dosimeter while the dosimeter is still on; once the dosimeter is turned off, the data will be erased.

4.14.2 Using Microsoft Works 3.0 For Dos

Access the WORKS program, and follow the prompts. Data is first received by the Communications portion of WORKS, then moved to the word processor portion, and finally into the spreadsheet.

From the Quick Start Options Menu, select "Create a New File" and then continue below:

4.15 Error Message

If the display indicates "ERRO3", turn off the dosimeter and wait 10 seconds. Then turn the dosimeter on. This resets the 897 and the calibration is unaffected.

Communications <OK>

Options

Communication

Baud Rate [match the 897--try 9600]

Data Bits [8]

Stop Bits [1]

Handshake [Hardware]

Parity [None]

Port [COM1 or COM2], as required

<OK>

File Save [this will save the setup]

Transfer

Capture Text

Save file as [897.DAT] <OK>

Connect

Connect

>> On the 897, slide the "OFF-ON-HOLD" SWITCH TO "HOLD" AND PRESS "PRINT". You will see the data appear on the computer screen. When the data stops appearing...

Connect

Connect

OK to disconnect? <OK>

File

Close

File

Open Existing File

897.DAT <OK>

Open File As <Word Processor>

<OK>

Select

Replace

Search for [*.....]

<Replace All> <OK>

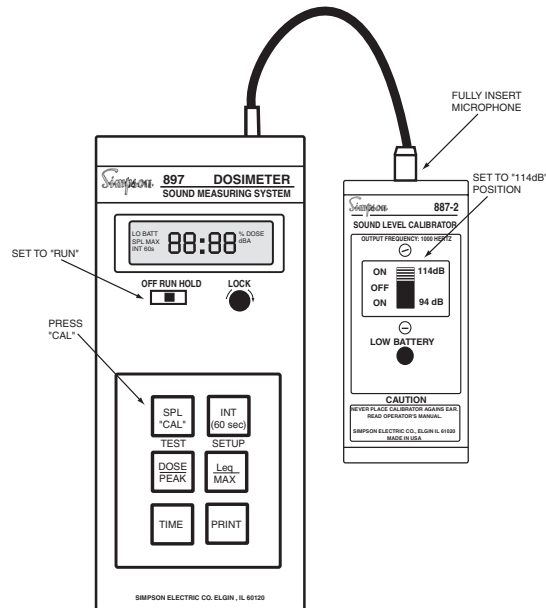

Figure 4-5. Calibration Hookup

- f. (Optional) The time and date of this calibration may be recorded in the Instrument's memory by pressing and holding the "SPL (CAL)" switch until the display flashes "CAL." The Instrument will retain the two most recent such occurrences, which may be observed only via the DATA OUTPUT. Due to changes in atmospheric conditions, it is recommended that Instrument calibrations be conducted and recorded at the beginning and end of the day.
- g. Turn off the calibrator, remove the microphone and replace the windscreen.

4.14 Dosimeter Application

The following text describes how to transfer data from the Simpson 897 Dosimeter into an IBM-compatible computer using Microsoft Works.

Using the optional RS-232-C serial cable, catalog #02233, connect the 897 to your computer's serial port, either COM1 or COM2.

4.14.1 Using Microsoft Works 4.0

1. Start Works 4.0
2. In Works Task Launcher, go to Works Tools.
3. Click on Communications.
4. Close the Easy Connect window if necessary.
5. Click on Settings and then Communications.
6. Choose the COM Port that the Dosimeter is connected to, then click on Properties.
7. Set Port Settings to match the Dosimeter (Flow control=Xon/Xoff), click OK.
8. Click OK again.
9. Click on the Dial/Hang-up button on the toolbar.
10. Press PRINT on the Dosimeter.
11. Data should now be displayed.

NOTES

START: 25/JAN/02 08:23
 CAL: 114.0 dBA 08:09 25/JAN/02 RANGE: 80/130 dB
 CAL: 114.0 dBa 08:40 25/JAN/02 RANGE: 80/130 dB
 DOSE: 108.0%
 LEQ 115.5
 SPL-Max *130.0
 Lc 90
 th 80
 rt 5
 id 01
 Pk 0
 ET 17
 HT 2

ET	L _{AVG}	LMAX	PEAKS	RANGE	HOLD
1	91.1	91.4	0	1	0
2	99.1	105.6	0	1	0
3	129.7	*130.0	0	1	0
4	130.0	*130.0	0	1	0
5	106.2	*130.0	0	1	0
6	*00.0	*00.0	0	1	0
7	*00.0	*00.0	0	0	0
8	95.9	96.7	0	1	0
9	89.9	96.7	0	1	0
10	80.1	80.3	0	1	0
11	80.5	94.6	0	-1	0
12	53.9	54.6	0	0	0
13	53.6	54.7	0	0	0
14	53.0	54.4	0	0	0
15	52.1	53.5	0	0	0
16	52.1	52.3	0	0	1
17	*00.0	*00.0	0	0	1

- NOTES: 1. When read by a spreadsheet program such as Microsoft Works™, the L_{AVG}, L-MAX, PEAKS, RANGE AND HOLD columns will be aligned.
 2. *00.0 indicates an underrange reading
 *100.0 or *130.0 indicates an overrange reading

Figure 4-5. Sample Printout - Spreadsheet Serial Format 1 (Prn 1)

4.13 Calibration

Always check the calibration before making any measurement. Use the Simpson Sound Level Calibrator, Model 887, Series 2.

- Remove the windscreen (if used) and carefully insert the microphone fully into the acoustic cavity of the Calibrator.
- Set the calibrator power switch to the "ON" position and check that the calibrator battery is okay.



Never place the operating calibrator tightly against the ear. The high sound level could be harmful, especially to someone with a hearing deficiency.

- Set the "OFF-RUN-HOLD" slide switch in the 897 to the "RUN" position. Wait until the Display Test sequence is completed, then depress the SPL (CAL) switch.
- Select the desired range: For checking at 94 dB use the 50/100 range; for checking at 114 dB use the 80/130 range.
- If calibration is required, using the screwdriver supplied with the calibrator, turn the adjustment control until a reading of either 94.0 dB or 114.0 dB is indicated on the display.

A sample of the Spreadsheet output format is illustrated in Figure 4-5. It is very similar to the summary report, except it does not include a histogram and the minute-by-minute data is not in real-time but in elapsed time. The Spread-Sheet output is once for each minute of data saved by the data logger; that is once for each minute of Elapsed Run Time (ET).

- L_{AVG} is the integrated (60 sec) reading.
- L_{MAX} is the maximum sound pressure level for this minute.
- PEAKS is the number of 140 dB peaks detected this minute.
- RANGE can be 0 for the 50/100 range, 1 for 80/130 or -1 if the range switch changed during this minute.
- HOLD is a number "flag" with a 1 signifying that the dosimeter was in "RUN".

The Spreadsheet Output format is diagramed in Table 4-4. Note that each data item is separated by two spaces.

Table 4-4. Spreadsheet Output Format

Actual Output	Description
Start:<sp><sp>25/JAN/02<sp><sp>00:00<CR><LF>	Starting date and time for this period
CAL:<sp><sp>0.0<sp>dBA<sp><sp>00:00<sp><sp>25/JAN/100<sp><sp>RANGE:<sp><sp>80/130<sp><sp>dB<CR><LF>	The dBA reading, time, date and range switch setting for each of two possible calibration readings. If the output data is only CAL:<sp><sp>?<CR><LF> then there is no calibration reading stored. Also, "RANGE:" may be 50/100.
DOSE:<sp><sp>0.0<CR><LF>	The calculated dose in percentage
Leq:<sp><sp>000.0<CR><LF>	The calculated 8-hour Time Weighted Average (TWA) in dBA
SPL-Max<sp><sp>000.0<CR><LF>	The detected maximum SPL for this data period
Lc<sp><sp>nn<CR><LF>	Criterion Level in dB
Th<sp><sp>nn<CR><LF>	Threshold in dB
rt<sp><sp>n<CR><LF>	Exchange Rate in dB
ID<sp><sp>nn<CR><LF>	Unit I.D. Number
Pk<sp><sp>nnn<CR><LF>	Number of 140 dB peaks
ET<sp><sp>nnnn<CR><LF>	Elapsed Run Time in minutes
HT<sp><sp>nnn<CR><LF><CR><LF>	Elapsed Hold Time in minutes
ET<sp><sp>L_{AVG}<sp><sp>MAX<sp><sp>PEAKS<sp><sp>RANGE<sp><sp>HOLD<CR><LF>	

1. INTRODUCTION

1.1 General Description

The Simpson Model 897 is a combination dosimeter and Class S2A sound level meter. It is a portable, easy-to-operate, accurate digital sound measurement instrument designed to meet the requirements of OSHA and international noise exposure regulations.

The 897 has a built-in data logger with a 31 hour storage capability. There are two standard output formats available with the data logger, a Centronics compatible parallel printer and an RS-232C serial printer or computer. The 897 also meets the requirements for the American National Standard Institute (ANSI) Specification S1.4-1983 and IEC651 for class S2A sound level meters and American National Standard Institute (ANSI) Specification S1.25-1978 for Personal Noise Dosimeters.

Measuring continuous, intermittent and impulsive noise in the standard range from 80 dBA to 130 dBA, the 897 also offers a 50 to 100 dB range where lower sound level analysis is desired. When used as a personal noise dosimeter, the 897 may be worn in a shirt pocket or on a belt. The microphone is provided with a clip which can be attached to the operator's shirt close to the ear.

When used as a sound level meter, the Instrument is hand-held. A front end attachment, properly contoured to avoid interference with incoming sound waves, holds the microphone. The advanced microcomputer, large digital display and special electret-condenser microphone offers easy operation and readability, and excellent performance and reliability.

1.2 Items Furnished With Instrument

All items furnished with the 897 are listed in Table 1-1.

Table 1-1. Items Furnished with the Instrument

Qty	Description	Part No.
1	Windscreen Dust Cover	5-119753
1	Microphone Clip	5-119752
1	Splined Wrench	6-113274
1	Screwdriver, adjusting	5-116470
1	Microphone Adapter	10-865235
1	Operator's Manual	6-115891
1	Parallel Cable	02234
1	AC Charger	6-115095
1	Carrying Case	10-865926

Optional Items

Description	Part No.
887-2 Sound Level Calibrator	12648
RS-232 Serial Cable	02233

1.3 Technical Data

The 897 conforms to ANSI S1.4-1983, ANSI S1.25-1978, and IEC651 (1979) standards for type S2A sound level meters and noise dosimeters.

Table 1-2 lists the technical specifications for the 897 Noise Dosimeter/Sound Level Meter.

Table 1-2. Instrument Specifications

Dosimeter Specifications

1. **Microphone:**
Type: 0.52 inch (13.2 mm) diameter electret condenser.
Maximum Pressure: 148 dBA sound pressure level.
Impedance: 1 KΩ
Directional Characteristics: Omnidirectional. The free field angle of incidence which closely approximates the random response is 70°.
2. **Threshold Level:**
The threshold level is selectable over the range of 50 to 99 dB, in 1 dB increments, from the front panel. The dosimeter function of the 897 is nonresponsive to noise levels below the threshold setting.
3. **Dose:**
Resolution: 0.1% dose to 999.9%; above 1000%, display will automatically convert to a higher range.
Maximum Indication: Dual automatic ranging: either 999.9% or 9999%. 100% corresponds to a criterion level noise exposure for eight hours; 50% corresponds to an eight hour noise exposure equal to the criterion level minus the exchange rate.
4. **Leq Display:**
Displays with 0.1 dB resolution. Selectable upper limit of 115 or 130 dB.
5. **Criterion Level:**
Selectable at 70, 80, 84, 85 or 90 dB from the front panel.
6. **Exchange Rates:**
3, 4 or 5 dB, selectable from the front panel.
7. **Elapsed Time:**
Displays either hours:minutes or minutes:seconds, up to 99 hours, 59 minutes, 59 seconds. Timing accuracy: 6 0.05%.
8. **Dynamic Range:**
Two switch selectable ranges, 50 to 100 dB and 80 to 130 dB.
9. **Accuracy:**
True RMS, per ANSI S1.4-1983, type S2 requirements.
10. **Frequency Response**
Weighting: "A" weighting.
11. **Response Time:**
Slow (1 second).
12. **Crest Factor:**
10:1 at maximum indication.
13. **Frequency Range:**
31.5 Hz to 8 KHz.
14. **Sound Pressure Reference:**
0 dB = 20 μ Pascals.
15. **Linearity: 60.5 dB @ 1 KHz:**
50/100 Range: >60dB; 80/130 Range: >90dB
16. **Criterion Duration (Tc):**
8 hours.

Hrs:Min is the real-time that the data was logged.

L_{AVG} is the integrated (60 sec) reading.

L-MAX is the maximum sound pressure level for that minute.

PEAKS is the number of 140 dB peaks detected in that minute.

RANGE is the range setting selected during that minute.

Readings preceded by an asterisk indicate they were either overrange or underrange:

* 00.0 indicates an underrange reading (under 50 on the 50 to 100 dB range or under 80 on the 80 to 130 dB range).

* 100.0 indicates an overrange reading on the 50 to 100 dB range.

* 130.0 indicates an overrange reading on the 80 to 130 dB range.

4.12 Spreadsheet Output Format "Prn 1"

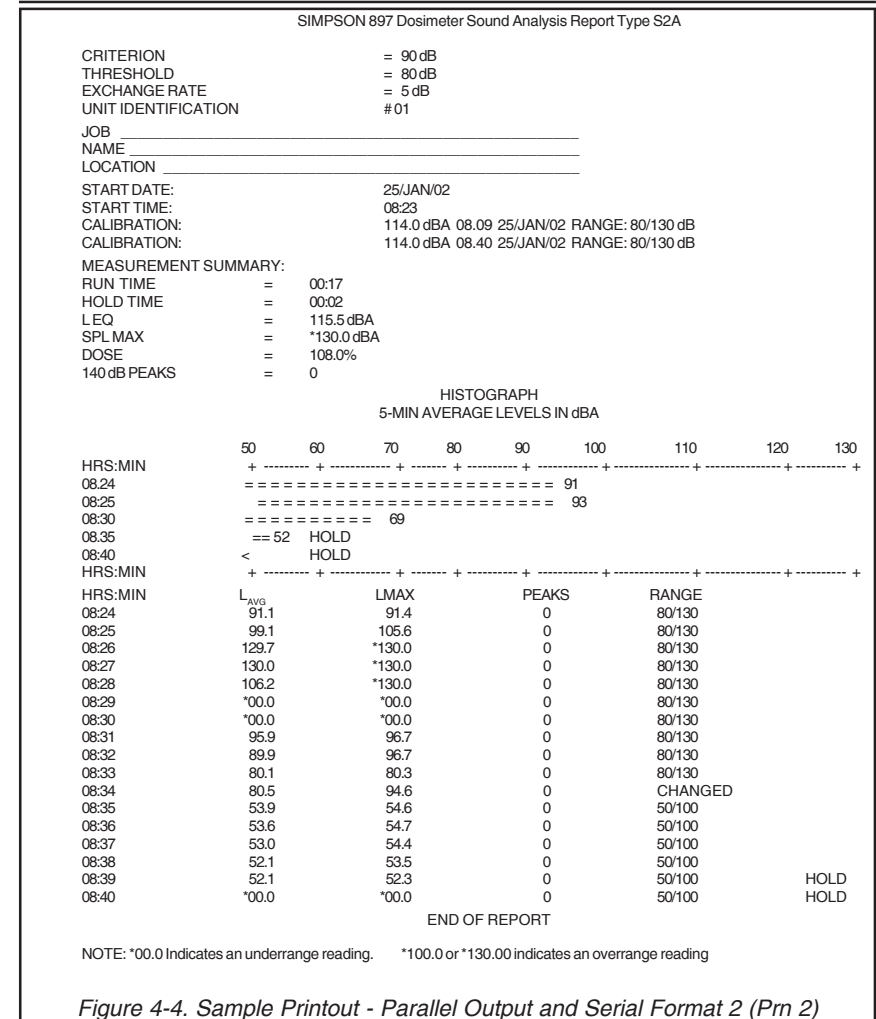

Figure 4-4. Sample Printout - Parallel Output and Serial Format 2 (Prn 2)

observed during the preceding minute (not the same as the MAX function switch), the number of 140 dB peaks during the preceding minute, the RANGE switch setting, and the occurrence of the dosimeter entering the "HOLD" mode. This data is available only via the "Data Output" connector.

4.10 Data Output Formats

Two standard output formats are available from the data logger of the dosimeter: a summary report that can be printed on either a parallel printer, or an RS-232C serial printer, and an output that is ideally formatted as input into a multi-column spreadsheet type program such as Microsoft Works™. Each output format includes information of total "HOLD" time, dose, Leq, SPL MAX, total number of 140 dB peaks, and a minute-by-minute output of the data logger. Following are sample printouts of the same data recorded by the 897 in each of the output formats. To obtain a printout in either one of the formats: first set the dosimeter to "HOLD", then press the "PRINT" button to print the data.

4.11 Parallel Output And Serial Format 2 "Prn 2"

A sample of the summary report is illustrated in Figure 4-3. The report is divided into four parts for explanatory reasons: Heading, Measurement Summary, Histogram, and the Minute-by-Minute Data Logger Output.

Heading includes:

Type of report, measurement parameters set by the operator, location and job identification as assigned by the operator

Date and time the Instrument was first set in "RUN" mode of operation. Also included are calibration data and time if recorded by the operator. (See paragraph 4.13 for calibration instructions.)

Measurement Summary includes the following:

- Run Time: Total time Instrument was in "RUN" mode.
- Hold Time: Total time Instrument was in "HOLD" mode of operation.
- Leq: The eight hour TWA (time weighted average) expressed in dBA. This measurement can be from the threshold level, set by the operator, up to 130 dB.
- SPL Max: The maximum sound pressure level recorded by the data logger.
- DOSE: The calculated dose (in percent). A 100% equates to a criterion noise level exposure for an eight hour time period.
- 140 dB Peaks: Total number of 140 dB peaks recorded.

Histogram presents five minute averages of the minute-by-minute L_{AVG} readings. The histogram is independent of the range setting, however, when the L_{AVG} readings are either underrange as indicated by * 00.0; or overrange as indicated by * 100.0 or * 130.0, then these readings are averaged into the 5 minute summary. For example; if $L_{AVG} = * 00.0$, as noted in Figure 4-3, then 0.0 dB is averaged in the five minute histogram.

Note that the five minute averages start on the minute ending in either a 0 or a 5, therefore, the initial and final averages may be less than 5 minute interval averages, as noted in Figure 4-3. The Instrument was in either the "HOLD" or "SPL" mode of operation at anytime during the five minute interval, if the reading is followed by the word "HOLD".

Minute-by-Minute Data Logger Output includes the following:

- 17. Calibration:** Instantaneous with 100 Hz, 94 dB or 114 dB SPL calibrator and adjustment on the top of the 897. However, an annual factory recalibration is recommended.
- 18. 140 dB Peaks:** Front panel selectable display indicates number of 140 dB peaks that have been detected.
One minute.
- 19. Warm-up Time:**
- 20: Data Logger**
 - Recording Time: 31 hours maximum. Any data beyond this time is not stored; only the first 31 hours are retained.
 - Stored Information:
 - a. The integrated 60 second average (L_{AVG}).
 - b. The highest SPL (L_{max}).
 - c. The number of detected 140 dB peak occurrences.
 - d. "HOLD" switch status.
 - e. "RANGE" switch status.
 - Storage Rate: Data is stored at 00:01:00 (hrs:min:sec) and once per minute thereafter.
 - Data Retention: Data is retained for as long as the unit remains powered in the "RUN" or "HOLD" modes; all data is lost in the "OFF" mode. However, to minimize the chance that data may be lost inadvertently, the data is retained for 3 seconds after the power is turned off.
 - Data Output Port:
 - Parallel: With supplied cable, communicates with any Centronics compatible, 80 column printer.
 - RS-232C Serial: With accessory cable, catalog #02233, communicates with any serial computer port at baud rates of 300, 600, 1200, 2400, 4800 or 9600. (Serial port set for 8 bit words, no parity, 1 stop bit). It will also function with many RS-232C serial printers.
 - Data Output Format:
 - Parallel: Includes criterion level, threshold level, elapsed run time, elapsed hold time, Leq, SPL MAX, dose, and number of 140 dB peaks. A five minute average level histogram is then output, which additionally gives indications of the RANGE switch setting and activation of "HOLD" mode. This is then followed by a complete listing of all stored information on a minute-by-minute basis. See para. 4:10 for further details.
 - Serial: Includes criterion level, threshold level, exchange rate, unit identification number, elapsed hold time. Leq, SPL MAX, dose, and number of 140 dB peaks. This is then followed by a complete listing of all stored in-

formation on a minute-by-minute basis. All of this data is formatted either for convenient input to a spreadsheet program, such as Microsoft Works 3.0 for DOS, or in the same format as the parallel printer.

Real-Time Clock: A real-time clock provides time and date information on the printout. The clock continues running even with power "OFF".



21. Power Requirements: The 897 is designed to be used with the Simpson battery charger, part number 6-115095, which is adequately insulated to permit use of the 897 while being charged. This charger has a rated input of 108 V AC to 264 V AC at 50/60 Hz. Use of any other charger may be hazardous to the operator or to the 897.

Internal Rechargeable Nickel-cadmium Battery Pack: Rechargeable with supplied recharger. Battery Life: Approximately 40 hours between charges in "RUN". Approximately 60 hours between charges in "HOLD".

NOTE: When the Instrument is switched to "RUN" and the display shows "ERR3" and "LO BATT", the battery must be charged at least 8 hours.

Low Battery Indicator: Automatically displays "LO BATT" to indicate at least eight hours of time remaining.

22. Display 4-digit liquid crystal display with six additional characters: SPL, SPL MAX, INT 60, LO BATT, % DOSE, dBA, plus a colon and decimal point.

23. Keyboard Selected Functions:

SPL(CAL): Sound Pressure Level
INT (60 Sec): Continuous 60 second integrated SPL (also referred to as L_{AVG}).

DOSE: In percent.
PEAK: The number of detected 140 dB peaks, up to a maximum of 250.

Leq: The eight-hour Time Weighted Average.
MAX: The maximum detected SPL.
TIME: Displays elapsed HRS:MIN or MIN:SEC.
PRINT: Activates the Data Output.

24. Mechanical Construction

Security Provisions: "Special" (#4 spline) wrench provided to lock "OFF-RUN-HOLD" slide switch into any po-

Clock, are saved in nonvolatile memory; the settings are retained even if the battery becomes fully discharged.

4.7 Security Controls

The 897 has been designed with two special security provisions to prevent unauthorized personnel from tampering with the control settings.

A function lockout feature prevents selected functions from being changed. This is accomplished by selecting the desired function, and while pressing this button, moving the "OFF-RUN-HOLD" control switch from "RUN" to the "HOLD" position and then back to the "RUN" position. The function touch pad is now disabled and no further function selections will be acknowledged. To regain control of the function selections, simply move the "OFF-RUN-HOLD" switch from "RUN" to "HOLD" and back to the "RUN" position.

The "OFF-RUN-HOLD" control switch can be locked in any one of the three positions by inserting the #4 spline wrench into the Bristol Screw located next to the switch and turning the screw clockwise.

4.8 Selection Of Parallel Or Serial Output Format

The selection of either the parallel or serial output is performed by the available accessory cables. No other user action is required, other than setting the RS-232 Baud Rate. The accessory RS-232 cable comes with a female dB-9 connector, which is standard on IBM PC/AT™ and compatible personal computers. The accessory parallel cable comes with a 36-pin connector that is compatible with most parallel-input printers. In the event that another custom cable configuration is required, the pinout of the "DATA OUTPUT" connector is shown below.

DATA OUTPUT PINOUT			
PIN	USE	PIN	USE
1.	Must not be connected for parallel. Must be connected to pin 4 for serial	9.	Parallel bit 7 output
2.	Parallel bit 6 output	10.	Serial data output
3.	Parallel bit 5 output	11.	Parallel bit 4 output
4.	Ground	12.	Parallel bit 3 output
5.	Parallel bit 2 output	13.	Ground
6.	Parallel bit 1 output	14.	Parallel bit 0 output
7.	Serial cts input	15.	Parallel data ready input
8.	Parallel data strobe output		

The requirements for the RS-232C output are: 8 bit words, no parity, 1 stop bit. Data is transmitted only; there is no "data receive" function. Handshaking is via one signal line, "CTS."

4.9 Automatic Data Logger

The dosimeter has a self-contained data logger with a 31 hour storage capability, and will store up to 31 hours of data, as long as the "OFF-RUN-HOLD" switch is never switched to "OFF" and/or the self-contained batteries do not become fully discharged. On a once-per-minute basis, the following information is logged: the present value of the INT (60 sec) function, the maximum sound pressure level

NOTE: In order to determine how much the Leq exceeds the OSHA upper limit of 115 dB, set the Leq to 130 dB.

Example:



- Serial Output, Option 1 or 2 (Prn): Option 1 formats the data in spreadsheet format for a computer; option 2 outputs the data formatted for a serial printer. This setting has no effect on the parallel output data format. This is factory set to option 1.

Example:



- Unit Identification Number (id), if multiple units are in service, units or tens digit: 0 through 9; thus the unit identification number may range from 00 to 99. This is factory set to unit #01.

Example:



- RS-232 Baud Rate (0000): 300, 600, 1200, 2400, 4800, or 9600 baud. This has no effect on the parallel output. It is factory set at 9600.
- Real-Time Clock - Set Time:
Set Minutes: Unit Digit (00:00) 9 through 9.
Set Minutes: Tens digit (00:00) 0 through 5.
Set Hours: (00:00) Select 00 through 23.

NOTE: Based on 24 hour clock

Example:

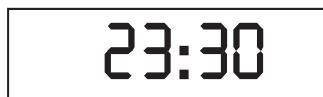

- Real-Time Clock - Set Date:
Set Day: (1-:N) N = number 01 through 31.
Set Month: (2-:N) N = number 01 through 12.
Set Year: Unit Digit: (3-:N) N = number 0 through 9.
Set Year: Decade Digit: (3-:N) N = number 0 through 9.

Example:



- Once all the parameter choices are made, switch the "OFF-RUN-HOLD" switch (see figure 4-1) to "OFF" for three seconds and all changes will be saved in the internal memory. It is unnecessary to go through the entire sequence; you may stop and switch the power "OFF" once all needed changes are made. All of the above parameters, with the exception of the Real-Time

sition. A keyboard switch "lockout" feature allows the 897 to be locked into any desired function.

Anodized aluminum extrusion.

Case Construction:

Physical Dimensions:

Length:

6.8 inches (172 mm)

Width:

3.1 inches (80 mm)

Thickness:

1.1 inches (28 mm), excluding microphone and clip.

Weight:

18 oz. (500 gm)

25. Environmental Specifications

Temperature:

Influence:

60.03 dB/°C, -10 to +25°C, 60.05 dB, +25 to 50°C (Reference 1000 Hz and 105 dB).

Operating Range:

-10 to 50°C.

Storage Range:

-30 to 45°C (limitation of batteries).

Humidity:

Influence:

Less than 0.5 dB over measurement range. 0 to 95% RH.

Range:

Magnetic Field:

No effect when placed in a field of 1 oersted (80 A/m) with Model 897 oriented for maximum sensitivity to the field.

Atmospheric Pressure:

Correction data is provided in the calibrator's operator's manual.

2. PREPARATION FOR USE

This section contains instructions for preparing the new Instrument for use. Also included are unpacking and inspection procedures, warranty and shipping instructions.

2.1 Unpacking And Inspection

Examine the shipping carton and Instrument for damage. If undamaged, check for internal damage. (Preliminary checks of the operating condition of the Instrument can be made after carefully reading Section 4). If there is external or internal damage, immediately file a complaint with the carrier. Make certain all items in Table 1-1 are included in shipment. Save the shipping carton for possible future shipping of the Instrument.

NOTE: The 897 is powered by a self-contained rechargeable nickel cadmium battery pack. Charge Instrument for 16 hours before use.

2.2 Preparation For Use

Accuracy of measurements can be affected by several factors, including the position of the microphone with respect to the sound source and the positioning of the microphone on the user. Read Section 3 carefully for general background information.

In operation, the Instrument can be attached to the belt with the clip provided, or can be placed in the shirt pocket. Ideally the microphone should be clipped

upright to the shirt on the center of the shoulder. If this is impractical, clip the microphone facing upward on the shirt collar. To protect the microphone in dusty or windy environments, place the windscreen over the microphone before attaching it to the shirt.

2.3 Warranty

The Simpson Electric Company warranty policy is printed on the inside front cover of this manual. Read it carefully before requesting warranty repairs. For all assistance, including help with the Instrument under warranty, contact the factory. Give full details of any difficulty and include the Instrument model number and date of purchase. Shipping instructions will be mailed promptly. If an estimate of charges for nonwarranty or other service work is required, a maximum charge estimate will be quoted. This charge will not be exceeded without prior approval.

2.4 Shipping

Pack the Instrument carefully and ship it prepaid and insured to the proper destination.

3. APPLICATION

This section contains the basic information required for effective application of the 897. To understand the operation of the Instrument, the following paragraphs discuss its function in relation to some of the subtleties of sound.

3.1 Decibel Scale

The human ear has a sound sensitivity range of greater than one million to one, from the lowest level that can be detected to the highest level that can be tolerated without pain. Because of the large ratio involved, a linear meter scale marked in sound pressure units becomes impractical. A scale based on logarithms, called a decibel (dB) scale, is used. This scale expresses the ratio between the sound pressure level being measured, with respect to a reference level and converts large ratios into smaller convenient numbers. For example, a million-to-one pressure ratio can be compressed on a 0 to 120 dB scale. The zero dB is the low limit reference which the human ear can barely perceive.

3.2 Sound Level Meter

A sound level meter is a measuring device used to determine the existing sound pressure level in a particular area. A choice of frequency responses called A, B and C “weightings” is typically provided which relate to the human ear response at low, middle and high sound pressure levels. The sound pressure level is expressed in dB A, dB B or dB C where 0 dB = 20 μ Pascals; the threshold of hearing and the A, B and C define the “weighting” selected. (See Figure 3-1).

NOTE: All OSHA type sound level meters must be A-weighted. B and C weightings are not required for compliance measurements.

The sound level meter function of the 897 meets the requirements of the American National Standards Institute (ANSI) Standard Specification S1.4 1983 for type S2A (“A” weighted) general purpose sound level meter.

number 1, 2 or 3, and should then freeze on this display. If this occurs, the Instrument must be returned for repair.

If these tests pass, the Instrument will proceed to a “rotating digits” test. This will cycle the display through all digits and all special annunciators. This test will continue until either the “TIME” switch is pressed or the “OFF-RUN-HOLD” switch is switched to “OFF.”

If the “TIME” switch was pressed, then the Instrument will continuously display the real-time clock until the “OFF-RUN-HOLD” switch is switched to “OFF.”

4.6 Setting The Dosimeter Parameters

4.6.1 The Dosimeter Parameters

Criterion Level (Lc), Threshold Level (Th), Exchange Rate (rt), Leq Upper Limit (H), Unit ID Number, Baud Rate and Time are easily programmable using the buttons located on the front panel.

4.6.2 To Program the Dosimeter

- Press and hold the “Setup” button (see Figure 4-1) while switching the “OFF-RUN-HOLD” switch (see Figure 4-1) from “OFF” to “RUN.”
- Select the parameter to be programmed by sequentially pressing the “Setup” button. The order of the sequence is given in Table 4-3, Setup Mode Sequence.
- Once the desired parameter is displayed, press the “Test” button (see Figure 4-1) to select the available choices of that parameter. The digit or digits which will change as a result of pressing the “Test” button will flash. The display prompt for each function is given within the parenthesis.

Table 4-3. Setup Mode Sequence

- Criterion Level (Lc): 70, 80, 84, 85, or 90 dB. Factory set at 90 dB as recommended by OSHA.

Example:

A rectangular digital display showing the text "Lc 90" in a seven-segment font. The "Lc" is on the left and "90" is on the right.

- Threshold Level, units digit (th): 0 through 9. Threshold Level, tens digit (th): 5 through 9; thus the threshold may be set to any value from 50 through 99 dB. Factory set at 80 dB.

Example:

A rectangular digital display showing the text "th 80" in a seven-segment font. The "th" is on the left and "80" is on the right.

- Exchange Rate (rt): 3, 4, or 5 dB. Factory set at 5 dB as recommended by OSHA.

Example:

A rectangular digital display showing the text "rt 5" in a seven-segment font. The "rt" is on the left and "5" is on the right.

- Leq Upper Limit (H): 115 or 130 dB. Factory set at 115 dB as recommended by OSHA.

The approximate required time to fully charge the battery pack, in hours, is linearly proportional to the operating time of the dosimeter. See graph (Figure 4-3) below.

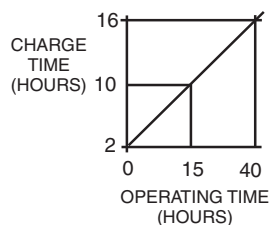

Figure 4-3

The Instrument will operate from the battery for approximately 40 hours between charges in the “RUN” position or approximately 60 hours between charges in the “HOLD” position, however, this time will vary according to use.

4.5 Preliminary Checks

Set the “OFF-RUN-HOLD” switch to the “RUN” position. When the unit is first turned on, a display segment test is performed. Next, the 897 will display in sequence given:

- Lc nn (Criterion Level)
- th nn (Threshold Level)
- rt n (Exchange Rate)
- SPL Display

Example:



4.5.1 Underrange Display

The display will indicate “ur” if the SPL is underrange; i.e., under 50 on the 50 to 100 dB range or under 80 on the 80 to 130 dB range.

4.5.2 Overrange Display

The display will indicate “- - -” if the SPL is overrange, i.e., over 100 on the 50 to 100 dB range, or over 130 on the 80 to 130 dB range.

4.5.3 Diagnostic Memory Test

The Instrument automatically performs a self diagnostic-memory test when turned on. However, the operator may access and display this self-test routine via the “TEST” switch. The self-test contains a complete memory diagnostic, a display test routine, and a continuous real-time clock display. These three tests are enabled by pressing the “TEST” switch down and sliding the “OFF-RUN-HOLD” switch to “RUN”. The display will first show “t 1.” If that passes, it will automatically proceed to “t 2” and “t 3.” Each of these tests (t) are verifying different portions of the internal memories. If any of these fail, the display will change to “Err” with the

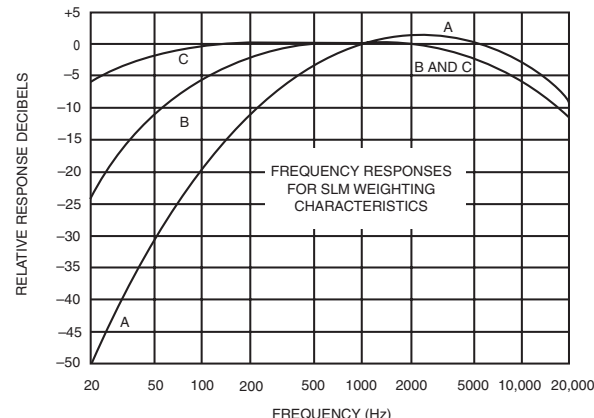

Figure 3-1. A, B & C Weighted Electrical Responses

3.3 Measurement And Exposure Standards

Sound level meter measurement standards are defined in American National Standards Institute (ANSI) Specification S1.4-1983. Federal, State and local governments also have defined allowable noise (undesirable sound energy) level exposure limits for persons in industrial environments. Selected and applicable parts of those currently in force are cited in this manual.

NOTE: Standards and government regulatory laws are subject to modification or expansion. Always check for latest available documents and information. The Occupational Safety and Health Act of 1970 (OSHA), The Walsh-Healy Act (Federal Register, Vol. 34, No. 96) and paragraph 1910.95 of the Occupational Safety and Health Standards (Federal Register, Vol. 46, No. 162), set the present legal standards of allowable employee noise exposure limits and are shown in Tables 3-1 and 3-2.

3.3.1 Steady Level or Slowly Varying Noise

Table 3-1. Permissible Noise Exposure Limits (Based on 90 dB criterion level and 5 dB exchange rate)

Duration Per Day in Hours	Sound Level, dB A SLOW Response
8	90
6	92
4	95
3	97
2	100
1 - 1/2	102
1	105
1/2	110
1/4 or less	115

Table 3-2. Permissible Noise Exposure Limits for Continuous Noise

Duration Per Day in Hours	Sound level dB A Slow response	Duration per day in hours	Sound level dB A Slow response
32	80	0.87	106
27.9	81	0.76	107
24.3	82	0.66	108
21.2	83	0.57	109
18.4	84	0.50	110
16.00	85	0.44	111
13.93	86	0.38	112
12.12	87	0.33	113
10.56	88	0.29	114
9.19	89	0.25	115
8.00	90	0.22	116
6.96	91	0.19	117
6.06	92	0.16	118
5.27	93	0.14	119
4.59	94	0.125	120
4.00	95	0.11	121
3.48	96	0.095	122
3.03	97	0.082	123
2.64	98	0.072	124
2.30	99	0.063	125
2.00	100	0.054	126
1.74	101	0.047	127
1.52	102	0.041	128
1.32	103	0.036	129
1.15	104	0.031	130
1.00	105		

Varying Level Noise

When daily noise exposure is composed of two or more periods of noise exposure at different levels, consider their combined effect rather than the individual effect of each. The total dose is computed by the expression:

$$D + \frac{C1}{T1} + \frac{C2}{T2} + \dots + \frac{Cn}{Tn}$$

Where: D is the noise dose; C1, C2 ... Cn are the actual segments of exposure time at different noise levels; and T1, T2 ... Tn are the allowed time intervals (see Table 4-1) for the mentioned segments of exposure. Unlike a sound level meter, a dosimeter computes automatically the exposure, D, and displays the accumulated percentage of the allowed exposure.

Duration computed from $\frac{B}{2 \exp(L-90) rt}$ where L = dB level, and rt = exchange rate = 5 dB, in this example table.

*From the Federal Register, Vol. 46, No. 162, August 21, 1981.

4.3 Top Panel Operating Features

Table 4-2. Top Panel Operating Features

- RANGE switch:** A 2-position switch that selects the operating range for sound level measurements. The available ranges are 50 to 100 dB and 80 to 130 dB. The data logger records the position of the switch and the time of any changes in the position.
- SPL (CAL) adjust:** Used with a calibrator to set the correct level.
- EXT DC:** Used with the supplied battery charger to recharge the internal nickel-cadmium batteries. The Dosimeter may be operated while connected to the charger.
- DATA OUTPUT CONNECTOR:** Use with either parallel or RS-232 Serial accessory cable to obtain data.

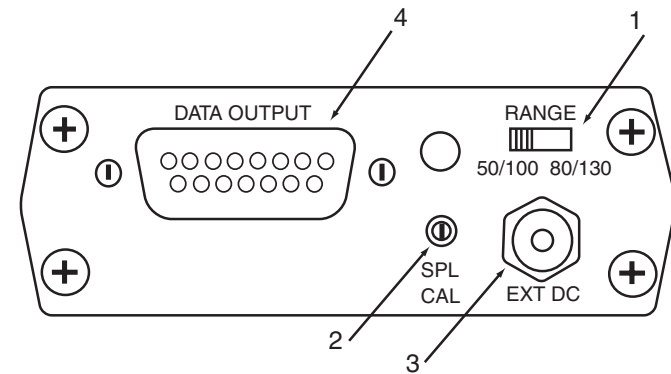

Figure 4-2. Top Panel

4.4 Battery Charging



The 897 is designed to be used with the Simpson Battery Charger (part no. 6-115095) which is insulated well enough to permit use of the 897 while being charged. This charger has a rated input of 108V AC to 264V AC at 50/60 Hz. Use of any other charger may be hazardous to the operator or the 897.

The self-contained, rechargeable nickel cadmium battery pack should be charged before operating the Instrument for the first time, or when the Low Battery Indicator "LO BATT" is displayed, or before extended use where a power source is not available.

The Instrument may be operated with the battery charger connected and thereby maintaining its charge, however, cycling of the charge is "healthy" for Ni-Cad batteries and extends their life. Do not attempt to keep them fully charged all the time.

are suspended and printouts will indicate "HOLD" during the time SPL is selected.

"HOLD": In "HOLD" mode all data is retained without any modification except that the elapsed time clock is kept running. The display will alternately flash between "HOLD" and the presently selected function.

2. Control Switch "LOCK":

A spline head screw is used to "lock" the control switch. Locking the control switch, together with the keyboard switch lockout feature, provides protection against unauthorized tampering with control settings. To activate the keyboard lockout, slide the "OFF-RUN-HOLD" switch to "HOLD", then select the desired function and while still holding that function button down, slide the "OFF-RUN-HOLD" switch to "RUN".

NOTE: The display will indicate four dashes (- - - -) for approximately five seconds. At this point, none of the touch switches will respond. The keyboard may be reactivated by again sliding the "OFF-RUN-HOLD" switch to "HOLD".

3. Readout Display:

Four-digit LCD display plus eight special functions/units.

4. SPL (CAL):

When selected, the Instrument functions as a sound level meter. It reads the incoming sound pressure level on a real time basis, and displays the A-weight dB reading.

NOTE: All dosimeter functions are suspended, and the printouts will indicate "HOLD" during the time SPL is selected. The "SPL" mode is also used to calibrate the Instrument when its microphone is inserted into the Model 887 Calibrator. When the "SPL (CAL)" button is held down for three seconds until "CAL" is displayed, the reading will be retained in memory along with the time, date, and position of the "RANGE" switch. The latest two such readings are always stored. These saved readings are only viewable with the data output printout.

5. DOSE/PEAK:

Alternately displays the DOSE in percent or the number of 140 dB (or greater) peaks that have been detected since entering "RUN".

6. TIME:

Alternately selects an elapsed time display of "minutes:seconds" or "hours:minutes" since the Dosimeter was first switched into "RUN" mode. "Hours:minutes" is displayed with a flashing color indicator.

7. INT (60 sec):

Displays the sound pressure level integrated average over a 60 second time period. The 60 second time period begins whenever the Dosimeter is switched into "RUN" from either "OFF" or "HOLD". It then updates continuously using the latest 60 seconds of accumulated sound pressure levels. Additional depressions of this button will sequentially display the latest settings of the programmable options, namely: criterion level, threshold level, exchange rate, time weighted average upper limit, serial output format, unit ID, baud rate and time clock. Notice that it is not possible to change the settings here, only to observe them. Refer to paragraph 4.6 for programming procedures.

8. Leq/Max:

Alternately displays Leq, based on eight hours, in dB or the maximum sound pressure level in dB since entering "RUN".

9. Print:

Instrument prints out one of the two output formats available from the data logger depending on which accessory cable is presently connected. This switch only functions while the Dosimeter is in the "HOLD" mode. (See paragraph 4.9 for further information.)

3.3.2 Impact Noise

For compliance, exposure to impulsive or impact noise must not exceed 140 dB A peak sound level.

3.4 Dosimeter

To accurately determine a dosage level using a sound level meter is a tedious procedure, as the total length of exposure at each dB level must be weighted and summed (accumulated). The dosimeter function of the 897 automatically and continuously performs these mathematical manipulations while it is operating and provides the dosage readout directly in percent of allowable exposure.

3.5 Dosimeter Equation

The dosimeter function is defined by ANSI S1.25 as:

$$\text{Dose (D)} = \frac{100}{T_c} \int_0^T 10^{\frac{L - L_c}{q}} dt \text{ (when } L > L_t)$$

Where $q = \frac{rt}{\log 2}$

Thus:

$$D = \frac{100}{T_c} \int_0^T 2^{\frac{L - L_c}{rt}} dt$$

Since the A/D converter is performing continuous integration, the computer must only resolve:

$$D = \frac{100}{T_c} \sum \frac{rt}{2^{\frac{L - L_c}{rt}}}$$

Note that the result is expressed as a percentage.

The equivalent sound level during the sample time, T, over which a percentage criterion exposure (dose) is measured, is: $Leq = L_c + q \log \frac{D}{100} \frac{T_c}{T}$

D = percentage criterion exposure;

Tc = criterion sound duration, defined as 8 hours;

T = actual exposure duration in hours;

L = slow, A-weighted sound level;

Lc = criterion sound level;

Lt = threshold level

rt = exchange rate: the change in sound level corresponding to a doubling or halving of the exposure duration.

User selectable items:

Lt = 50 to 99 db;

Lc = 70, 80, 84, 85 or 90 dB;

rt = 3, 4 or 5 dB.

Upper level of allowable equivalent (Leq) sound level exposure: 115 or 130 dB.

3.6 Sound Fields

3.6.1 Free Field

This field contains no reflecting objects. Ideally it is a point sound source located in free space; however, it can be considered to exist whenever the sound level being measured is caused mainly by the sound waves coming directly from the sound source. This can occur even if there are reflecting objects.

3.6.2 Reverberant Field

This field is more common and exists whenever the sound level being measured contains a significant amount of direct sound waves and a relatively small amount of reflected sound waves.

3.7 Microphone Orientation

3.7.1 Area Monitor in a Free Field

When the Instrument is used as a fixed monitor in a free field or in a semi-reverberant field, the axis of the microphone should be oriented at approximately 70° with incident sound waves. Furthermore, the microphone should ideally be placed as far from reflecting sound surfaces as possible. (See below.)

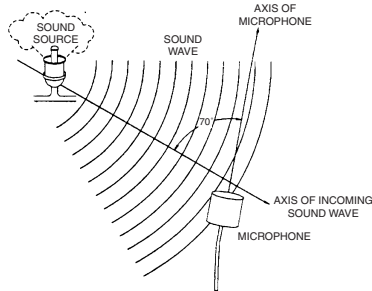

Figure 3-2. Microphone Orientation

3.7.2 Fixed Position Monitor in a Reverberant Field

When monitoring in a reverberant field, orientation of the microphone is not critical.

3.7.3 Use of Dosimeter as a Personal Monitor

For a practical and efficient application, clip the microphone to the shirt, on the shoulder just below the ear, with the microphone diaphragm facing upward.

NOTE: The user of the Instrument disturbs the sound field near the microphone at the upper limit of frequencies. For many practical situations, the measurement error is relatively small, typically 1 to 3 dB higher than would occur with a fixed monitor position. Since the fixed monitor cannot easily follow the motion of a mobile individual, the personal dosimeter is the most accurate, practical means of measuring individual noise dosage.

3.8 Windscreen

NOTE: When the 897 is exposed to a dusty or windy environment, the windscreen should be used to protect the microphone diaphragm from damage, and to assure a correct reading.

The windscreen will reduce the effects of wind noise by approximately 20 dB without seriously affecting the frequency response of the microphone.

Grease and dirt on the windscreen may affect the accuracy of sound measurements. Under severe conditions the windscreen should be cleaned often. To clean, wash with a mild detergent, thoroughly rinse and dry before placing over the microphone.

4. OPERATION

This section provides the instructions required for the operation of the 897.

4.1 Safety Precautions

Read Section 3 before performing dosage measurements. Section 3 contains important information pertaining to sound and noise measurement terminology, standards, operating techniques and precautions.

4.2 Operating Items And Features

All front panel operating controls are described in Table 4-1 and shown in Figure 4-1. Top panel adjustments, controls and connectors are described in Table 4-2 and shown in Figure 4-2.

Table 4-1. Front Panel Operating Features

1. “OFF-RUN-HOLD” Control Switch:

A 3-position slide switch used to activate the Instrument and “hold” accumulated data.

“OFF”: Power is removed from the Instrument and all accumulated data is erased. When switching from “RUN” to “OFF”, there is a minimum three second delay before the 897 actually goes off. This will aid in preventing accidental loss of accumulated data. During this three second period, the display may appear dim; this is normal operation.

“RUN”: In “RUN” mode all data relating to DOSE, Leq, INT (60 sec), MAX and PEAK is continuously monitored, updated and stored, except when in SPL mode of operation. In the SPL mode, all dosimeter functions

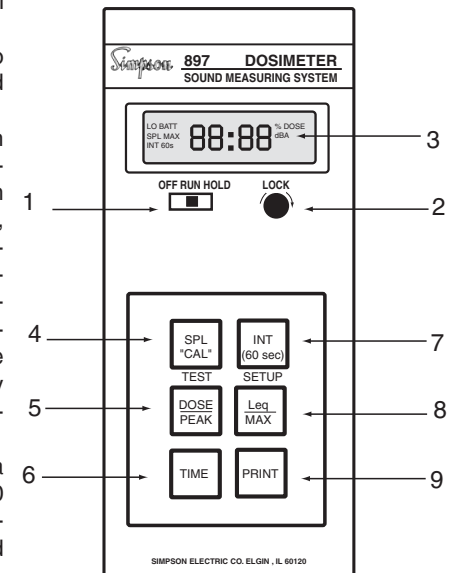

Figure 4-1. Front Panel