

*Simpson*

**Model 228  
Current Leakage Tester  
INSTRUCTION MANUAL**



### **About this Manual**

To the best of our knowledge and at the time written, the information contained in this document is technically correct and the procedures accurate and adequate to operate this instrument in compliance with its original advertised specifications.

### **Notes and Safety Information**

This Operator's Manual contains warning headings which alert the user to check for hazardous conditions. These appear throughout this manual where applicable and are defined below. To ensure the safety of operating performance of this instrument, these instructions must be adhered to.



Warning, refer to accompanying documents.



Caution, risk of electric shock.

### **Technical Assistance**

SIMPSON ELECTRIC COMPANY offers assistance Monday through Friday 7:30 am to 5:00 pm Central Time by contacting Technical Support or Customer Service at (847) 697-2260.

Internet: <http://www.simpsonelectric.com>

### **Warranty and Returns**

SIMPSON ELECTRIC COMPANY warrants each instrument and other articles manufactured by it to be free from defects in material and workmanship under normal use and service, its obligation under this warranty being limited to making good at its factory or other article of equipment which shall within one (1) year after delivery of such instrument or other article of equipment to the original purchaser be returned intact to it, or to one of its authorized service centers, with transportation charges prepaid, and which its examination shall disclose to its satisfaction to have been thus defective; this warranty being expressly in lieu of all other warranties expressed or implied and of all other obligations or liabilities on its part, and SIMPSON ELECTRIC COMPANY neither assumes nor authorizes any other persons to assume for it any other liability in connection with the sales of its products.

This warranty shall not apply to any instrument or other article of equipment which shall have been repaired or altered outside the SIMPSON ELECTRIC COMPANY factory or authorized service centers, nor which has been subject to misuse, negligence or accident, incorrect wiring by others, or installation or use not in accord with instructions furnished by the manufacturer.

This manual represents your meter as manufactured at the time of publication. It assumes standard software. Special versions of software may be fitted, in which case you will be provided with additional details.

The apparatus has been designed and tested in accordance with EN 61010-1, "Safety Requirements for Electrical Equipment for Measurement, Control and Laboratory Use." This operating guide contains information and warnings that must

be followed by the user to ensure safe operation and to maintain the apparatus in a safe condition.

We reserve the right to make changes and improvements to the product without obligation to incorporate these changes and improvements into units previously shipped.



High Voltage Terminal: Use extreme care when making high voltage measurements; do not touch terminals or probe ends.



Limit voltage, with respect to earth ground, to 600VDC/VAC maximum.



A terminal connected to earth ground.



This Instrument is designed to prevent accidental shock to the operator when properly used. However, no engineering design can render safe an instrument which is used carelessly. Therefore, this manual must be read carefully and completely before making any measurements. Failure to follow directions can result in a serious or fatal accident.

**SHOCK HAZARD:** As defined in IEC-1010-2, *Safety Requirements for Electrical & Electronic Measurement, Control and Laboratory Use*, a shock hazard shall be considered to exist at any part involving a potential in excess of 30 volts RMS (sine wave) or 42.4 volts DC or peak and where a leakage current from that part to ground exceeds 0.5 MIU (Measurement Indication Units) when measured with an appropriate measuring instrument defined in Section 6.3.1.2 annex A of IEC-1010-1.

**NOTE:** UL-1244 calls for the same voltage and measurement limits as IEC-1010-1:1990 but UL-1244 specifies a slightly different test network. Simpson Electric manufactures test equipment to measure shock hazard as set forth by both specifications. The Simpson Model 228 uses the networks specified by IEC-1010-1 and is suitable for measuring shock hazard as defined in that document. The Simpson 229-2 uses the measurement networks specified in UL-1244 and is suitable for measuring shock hazard as defined in that document.

Instruments such as the Model 228 are intended for use in relatively low power 120/240 VAC or dry battery operated circuits. Never use this Instrument for measurements in high-energy or high-power circuitry such as power substations, distribution centers, RF induction heaters, broadcast transmitters and X-ray equipment. The **Safety Precautions** in this manual alert you to such hazards and the protective measures necessary to avoid injury or equipment damage. The dangers in high power circuits are serious. **Please observe all safety precautions!**

# Contents

1. INTRODUCTION .....	5
1.1 General Description .....	5
1.2 What Is Leakage Current? .....	5
1.3 Human Response to Electrical Shock .....	6
1.4 Shock Hazard .....	7
1.5 Burn Hazard .....	7
1.6 Inspection of Instrument .....	7
1.7 Components and Accessories .....	7
2. SPECIFICATIONS .....	8
3. CONTROLS AND FUNCTIONS .....	9
4. INTERPRETING THE METER DIAL SCALES .....	10
5. READING THE METER DIAL SCALES .....	11
6. SAFETY PRECAUTIONS .....	11
7. MEASUREMENT PROCEDURES .....	12
7.1 General .....	12
7.2 Preparation .....	13
7.3 Voltage Measurement .....	13
7.4 Burn Hazard Measurement .....	14
7.5 Shock Hazard Measurement .....	15
7.6 Polarity Reversal .....	15
8. MAINTENANCE AND CARE .....	16
8.1 Service .....	16
8.2 Battery Replacement .....	16
8.3 Fuse Replacement .....	17
9. CARE OF INSTRUMENT .....	17
10. RMS VS. PEAK .....	18

# 1. INTRODUCTION

---

## 1.1 General Description

---

The Simpson Model 228 is a special purpose AC/DC milliammeter that measures potentially hazardous leakage current on electrical and electronic equipment. This Instrument meets the guidelines published in IEC 990, "Methods of Measurement of Touch Current and Protective Conductor Current." Most standards agencies in the United States — including ANSI, ISA and UL are in the process of implementing the networks from IEC 990 into their specifications.

**NOTE:** For specification information call:  
ANSI at (212) 642-4900 or  
UL in Northbrook, IL at (847) 272-8800.

The Model 228 tests equipment operating at 120-220 volts AC or DC power line circuits only. Instrument features include:

- Separate leakage current networks for measuring the following electrical shock response levels:
  - Perception/reaction (shock hazard)
  - Let-go (shock hazard)
  - Burn hazard
- 0-300 volt scale for measuring open circuit voltage between accessible parts and ground.
- An RMS reading meter with scales that read shock hazard up to 10 Measurement Indication Units (MIU), burn hazard up to 100 mA and peak indicating RMS shock hazard. (Refer to Section 7, Measurement Procedures) for more information.
- Output connections for an external peak reading Instrument (required for measuring peak readings on non-sinusoidal waveforms).
- Convenient battery test function.



The 228 is battery operated. In some applications, the lead attached to the "Ground" input may not be attached to earth ground. As a result, the output jacks may be "floating." To prevent a shock hazard, do not connect any connectors or equipment with accessible conductive surfaces.

## 1.2 What Is Leakage Current?

---

"Leakage Current" is a generic term applied to many forms of unwanted currents. "Leakage Current" (or more accurately, "Touch Current") as it relates to electrical shock hazards, is the current that flows to ground through the human body due to inadequate insulation or improper grounding between internal supplies and accessible conductive parts.

In properly designed and installed equipment, leakage current can usually be ignored because it is limited to safe levels. Excessive leakage current can appear in equipment as a result of:

- A defective component
- Poor equipment design or installation
- A build up of foreign matter
- Old or deteriorated insulation

The presence of leakage current on any accessible conductive part poses a potential shock hazard to anyone touching that part (see Figure 1). Severe electrical shocks from leakage current can cause burns, serious injury and in some cases, death. Even when leakage currents are not high enough to directly injure a person, the current can be high enough to cause a violent muscle contraction resulting in accident or injury.

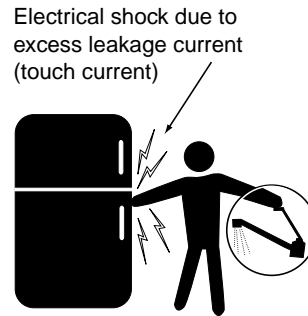

Figure 1.

Leakage current measurement ensures the safety of electrical equipment — not only for the user but for anyone who comes in contact with the equipment. Leakage current measurements should be performed whenever equipment is installed or repaired.

### 1.3 Human Response to Electrical Shock

The human body's reaction to electrical shock depends upon the magnitude of the current involved and many other variables, including sex, weight, age and point of contact. Reaction to a shock can range from a harmless tingling sensation to a more serious response such as violent muscle contractions, massive burns or death due to heart failure.

Although most electrical or electronic equipment is energized by 60Hz (50Hz) power circuits, some have solid state control circuits or power conversion circuits which generate higher frequency currents. This high-frequency current may be a significant part of the total leakage current. The human body becomes less sensitive to leakage current as the frequency is increased. The 228 takes the frequency of the leakage current into account when making measurements and displays a reading that correctly reflects the potential hazard from the leakage current. Because of this frequency correction, leakage currents are measured in Measurement Indications Units (MIU).

The IEC and other safety agencies have defined four (two are combined) levels of human body response to electrical shock:

- Perception/Reaction (tingling sensation and involuntary muscle contraction)
- Let-go (the loss of the ability to control muscles and release)
- Electric burns

The 228 includes a separate measurement "network" for each of these response levels.



**WARNING:** These response networks are for non-medical applications and do not include patient contact cases. This Instrument is not intended for use in medical applications.

## 1.4 Shock Hazard

---

The level at which leakage current will cause a shock varies greatly between people. As a result the IEC, UL, and other safety agencies set limits where most people will not feel a shock or will not react to any leakage current present. The most commonly used leakage current limit is 0.5 MIU RMS (0.7 MIU peak) using the reaction response network. This level is safe for most conditions and for most people, but there are cases where 0.5 MIU may pose a hazard. In those cases tighter limits are required. The safety agencies also acknowledge that some conditions exist where higher currents can be permitted without an increased risk of injury.

When making routine leakage current measurements as part of equipment maintenance, refer to the equipment manufacturer for the acceptable leakage current level. When using the 228 for testing safety of new designs, check with the appropriate safety agency for the correct leakage current limits.

## 1.5 Burn Hazard

---

Another potential leakage current hazard is electrical burns. Electrical burns can occur at current frequencies as low as 30KHz or lower. The potential of electrical burns is constant regardless of frequency and is measured in mA RMS. A limit of 70 mA is almost universally accepted as being a safe limit to prevent leakage current-related electrical burns.

## 1.6 Inspection of Instrument

---

Immediately upon receipt, inspect the Instrument for damage. Verify that your Instrument includes all of its components and accessories. If you find the unit to be damaged, notify the carrier and supplier immediately. **Do not use a damaged Instrument.**

## 1.7 Components and Accessories

---

- Operator's Manual
- Test Lead Set: Red and black insulated test probe set. Simpson Part Number 00125.
- Two (2) 9-volt, NEDA type 1604A alkaline batteries.

## 2. SPECIFICATIONS

Specification	Response Level		
	Reaction	Let-Go	Burn Hazard
Equivalent Measuring System Load	1M $\Omega$ , 10 pF	1M $\Omega$ , 62 pF	1M $\Omega$ , 1 pF
Ranges	0.3, 1, 3, 10 MIU		0-100 mA RMS
Current Accuracy	$\pm$ 2% FS @ 60 Hz		
Meter Measurement Method	True RMS		
Meter Frequency Response*			
DC to 1Hz	Pointer tracks within 5% of peak		
2Hz to 19Hz	Accuracy not supported		
20Hz to 200 KHz	$\pm$ 2% FS	$\pm$ 2.5% FS	$\pm$ 2% FS
200KHz to 1MHz	$\pm$ 2% FS	$\pm$ 2.5% FS	$\pm$ 5% FS
Output Accuracy	$\pm$ 2% of Reading @ 60 Hz		
Output Frequency Response*			
DC to 50Hz	$\pm$ 2% of Reading		
50Hz to 100KHz	$\pm$ 2.5% of Reading	+ 2%/-3% of Reading	$\pm$ 2% of Reading
100KHz to 1MHz	$\pm$ 5% of Reading		

\*Relative to ANSI C101-1992 or UL-1459 2nd edition

*Table 1.*  
*Specifications*

<b>Output Sensitivity:</b>	Full scale meter deflection equals 1 volt RMS (measured with a 1M $\Omega$ , 12 pF load)
<b>Voltmeter Range:</b>	0-300 volts (AC or DC)
<b>Voltmeter Accuracy:</b>	
DC to 1 Hz:	Pointer tracks within 5% of peak
2Hz to 19Hz (Accuracy not supported)	
20 Hz to 1 KHz:	$\pm$ 3% FS @ 60Hz (Add $\pm$ 1% for every additional 100Hz)
<b>Voltmeter Frequency Response:</b>	DC to 1KHz
<b>Power Source Requirements:</b>	Two (2) 9 volt, NEDA type 1604A alkaline batteries
<b>NOTE:</b>	Alkaline batteries have a VDC continuous use rated life of 400 hours or longer.
<b>Temperature Range:</b>	
Operating:	0° to 40°C
Storage:	-10° to 55°C
<b>Humidity Range:</b>	
Operating:	70% RH, non-condensing
<b>Dimensions:</b>	7" x 5¼" x 3-1/8" (18 cm x 13.6 cm x 8.2cm)



**Weight:** 2½ lbs. (1,134 g)

**Low-Battery Indication:** Instrument provides a battery test selection on power switch and corresponding scale on meter dial.

### 3. CONTROLS AND FUNCTIONS

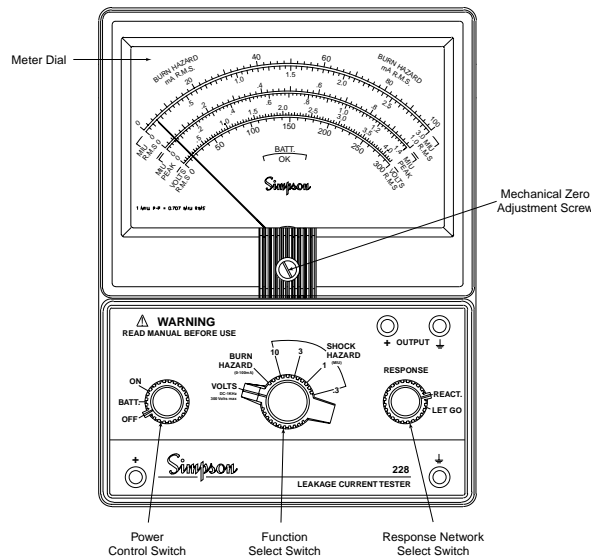

Figure 2. Controls and Functions

#### **Mechanical Zero Adjustment Screw**

Adjusts the meter pointer to zero when the instrument is turned **OFF**.

#### **Power Control Switch**

Turns the Instrument **ON** and **OFF**. Select the **BATT** setting before each use to determine battery condition. A weak battery may cause inaccurate readings.

#### **Function Select Switch**

Selects one of three operating modes: **VOLTS**, **BURN HAZARD** and **SHOCK HAZARD**.

#### **Response Network Select Switch**

Selects one of two shock hazard response networks: **REACT** and **LET GO**. This switch is used in conjunction with the **SHOCK HAZARD** setting on the Function Select Switch.

#### **Meter Dial**

Displays Instrument measurements. The meter dial has four measurement scales and a battery test scale.

**Burn Hazard Scale (measured in mA RMS)**

Used when selecting the **BURN HAZARD** function in order to read potential burn hazard leakage current.

**Shock Hazard Scales (measured in MIU RMS and MIU Peak)**

Used when selecting the **SHOCK HAZARD** function in order to measure shock hazard leakage current. The MIU Peak scale reads 1.4 times the RMS value and assumes a sinusoidal waveform.

**Important:** Read the MIU Peak scale only if the equipment specification calls for a peak reading and when certain that the leakage current is sinusoidal. See Section 10, RMS VS. PEAK, for more information on RMS and Peak measurement limits.

**Volts Scale (0-300 volts)**

Used when selecting the **VOLTS** function.

**Battery Scale**

Indicates battery condition when selecting the **BATT** function.

## **4. INTERPRETING THE METER DIAL SCALES**

Use the correct multiplier when reading Instrument measurements. Refer to Table 2 below.

*Table 2*

<b>Range Selected</b>	<b>Scale</b>	<b>Range Multiplier</b>
BATT	BATTERY OK	None
VOLTS	0-300 V	1
BURN HAZARD	0-100 mA RMS	1
10 MIU	0-1 MIU RMS	10
	0-1.4 MIU Peak	10
3 MIU	0-3 MIU RMS	1
	0-4.2 MIU Peak	1
1 MIU	0-1 MIU RMS	1
	0-1.4 MIU Peak	1
0.3 MIU	0-3 MIU RMS	0.1
	0-4.2 MIU Peak	0.1

## 5. READING THE METER DIAL SCALES

---

The analog meter scales require interpolation to obtain readings that fall in between the major scale markings. See Figure 3 below, as example.

Example: Burn hazard reading is 50mA RMS or  
MIU (bottom) reading is 1.5 MIU for the 3 MIU range

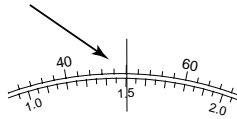

Figure 3

### “+” and “⊥” Input Jacks

Connect the red (positive) test lead to the “+” jack and the black (ground) test lead to the “⊥” jack.

### “+” and “⊥” Output Jacks

Connect the positive and ground leads from a peak reading device to these jacks. The Instrument output produces a scaled and buffered output voltage which matches the waveform of the leakage current. At full scale meter deflection, the output produces 1 volt RMS.



The output jack ground is tied to input jack ground. To avoid a “ground loop” condition, which can cause false readings or Instrument damage, do not tie the Instrument’s *output* ground jack to another ground.

### Battery Compartment

Compartment houses the two (2) 9 volt NEDA type 1604A alkaline batteries and input protection fuse. These are the only user serviceable parts in the Instrument.



Before opening the Instrument battery compartment, disconnect all test leads and turn the power switch OFF.

## 6. SAFETY PRECAUTIONS

---



Although designed to ensure operator safety, this instrument measures potentially fatal current and voltage levels. To guarantee safe operation, observe all warnings and cautions contained in this manual and in the technical manuals of the equipment under test.

Do not use this Instrument unless qualified to recognize shock hazards and trained in the safety precautions required to avoid injury. Become familiar with the **Definition of Shock Hazard** explained on Page 3 of this manual.

1. Do not work alone when measuring where a shock hazard may exist. Make certain that someone capable of giving aid is close by and is alert to potential problems.
2. Turn OFF the power to the equipment under test. Discharge any capacitors in the circuit before connecting or disconnecting the Instrument.
3. Be aware that voltages can appear unexpectedly in defective equipment. For example, an open bleeder resistor can allow a capacitor to retain a dangerous charge.
4. Locate all voltage sources and accessibility paths before making any connections or measurements.
5. Before using the Instrument, inspect the test leads and connectors for damage. Do not use, or permit the use of, damaged equipment.
6. Make sure hands and shoes, as well as floor and workbench, are dry. Avoid making measurements under damp and humid conditions.
7. Never touch the test leads, circuit or Instrument while power is applied to the circuit being measured.
8. Do not use test leads different from those originally furnished with the Instrument.

## **7. MEASUREMENT PROCEDURES**

---

### **7.1 General**

---

Measurement of current leakage involves a series of procedures:

1. Preparation
2. Voltage Measurement
3. Burn Hazard Network Measurement
4. Shock Hazard Network Measurement
5. Polarity Reversal Measurements

For a typical single unit test, all procedures are performed in sequence and the instructions that follow cover the complete series. However, for testing of a group of products or for special purpose applications, qualified users might only need to use a selected part of the full procedure.



Do not touch the equipment under test with power applied until voltage and current leakage measurements are within accepted limits.

**NOTE:** The following is based on set-up and test procedures from the applicable standards document (or from the equipment manufacturer) for correct main connection, detailed test procedures and leakage current limits. Figure 4, Page 13, shows a typical test setup. All items other than the 228 and its accessories must be provided by the user.

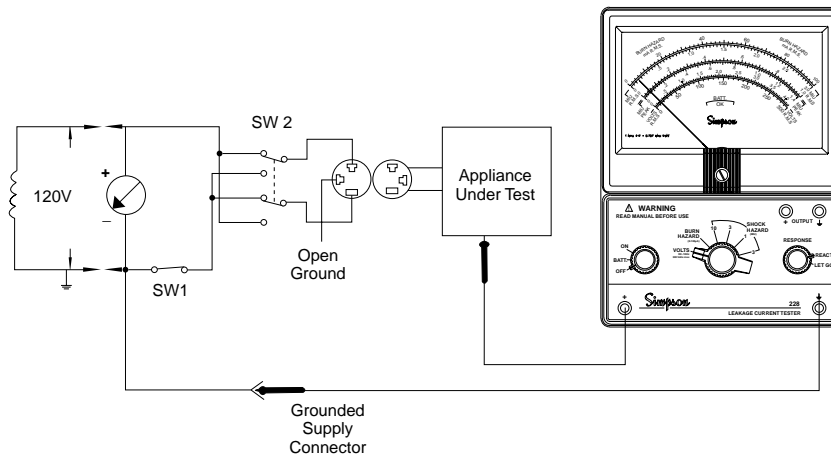

Figure 4. Typical Test Setup

## 7.2 Preparation

1. Turn power OFF to equipment under test.
2. If the meter pointer does not align with zero when Instrument power is OFF, rotate the mechanical zero adjustment screw as necessary.
3. Connect the Instrument and equipment under test. Figure 4, above, shows a typical test setup. Do not apply power.
4. Verify that proper line voltage is available for the equipment under test.
5. Turn the Instrument Power Switch to **BATT**. If pointer indicates satisfactory battery condition, proceed with testing. If not, turn Instrument Power Switch to **OFF** and replace the batteries before proceeding.

## 7.3 Voltage Measurement

1. Turn the Instrument **Power Switch** to **ON** (see figure 5 below)

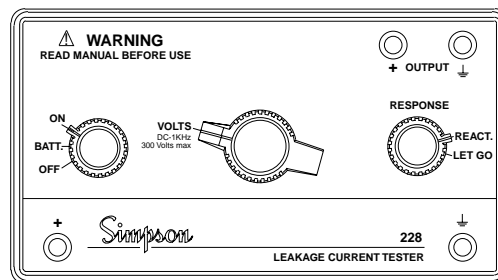

Figure 5

2. Connect Instrument Test Leads to the input jacks — red lead to “+” and black lead to “ $\frac{1}{\text{E}}$ ”.

3. Turn Function Select switch to **VOLTS**.
4. Connect Instrument Ground Test Lead to known good ground (such as a water pipe or power line ground).
5. With SW1 open, turn ON equipment under test.
6. Use Positive Test Lead to probe all accessible conductive surfaces to determine if excessive voltage is present. Read the 0-300 volts (bottom) scale.
  - a. If the voltage measurements appear normal, proceed to **Burn Hazard** test which follows.
  - b. If measured voltage is above expected value, check equipment for short circuits and make any necessary repairs before continuing. Abnormally high voltages that persist without corresponding short circuits indicate current leakage.

## 7.4 Burn Hazard Measurement

1. Turn Function Select switch to **BURN HAZARD** (see Figure 6 below).

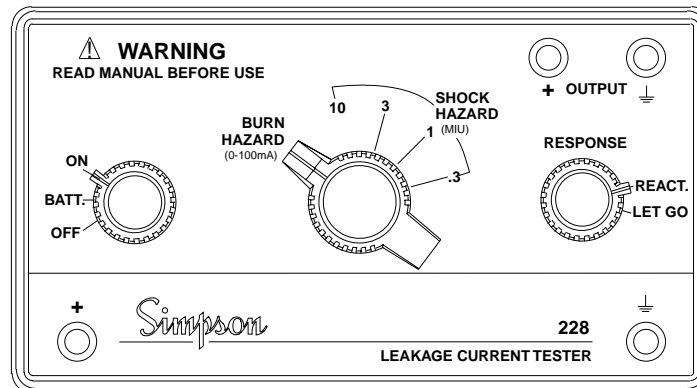

Figure 6

2. Use Positive Test Lead to probe all accessible conductive surfaces and check for excessive current leakage. Read the 0-100mA RMS scale.

**NOTE:** Most safety specifications set a limit of 70mA for this measurement. Refer to the appropriate specification (or equipment manufacturer) for the correct limit. Proceed only when burn hazard measurements are within acceptable limits.

## 7.5 Shock Hazard Measurement

1. Turn Function Select Switch to 10MIU SHOCK HAZARD (see Figure 7 below).

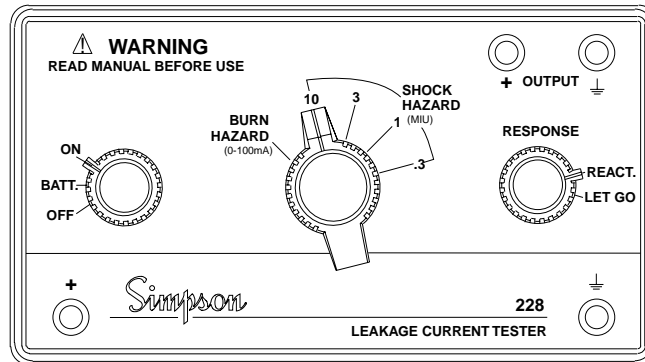

Figure 7

2. Use Positive Test Lead to probe all accessible conductive surfaces and check for excessive current leakage. Read the 0-10 MIU scale. If measured current is less than 1/3 of full scale, increase meter sensitivity by turning the Function Select switch clockwise until pointer is in upper 2/3 of the dial.

**Note:** ANSI C101.1 limits current leakage to 0.5 MIU RMS for most appliances, but exceptions are allowed for unique situations. Refer to the equipment manufacturer or applicable safety standard for more details. Proceed only when shock hazard measurements are within acceptable limits.

## 7.6 Polarity Reversal

1. Use SW2 switch (see figure 4, page 13) to reverse the hot and neutral. Do not close SW1 to activate the unit under test. Repeat Voltage, Burn Hazard, and Shock Hazard tests. After completing tests, return SW2 to original position.
2. Close SW1 and turn equipment on.
3. Use Positive Test Lead to probe all accessible conductive surfaces in order to determine if excessive voltage is present. Read the 0-300 volts (bottom) scale.
  - a. If the voltage measurements appear normal, proceed to step 4.
  - b. If measured voltage is above expected value, check equipment for short circuits and make any necessary repairs before continuing. Abnormally high voltages that persist without corresponding short circuits indicate current leakage.
4. Turn Function Select switch to **BURN HAZARD** (see Figure 6, page 14).
5. Use Positive Test Lead to probe all accessible conductive surfaces and check for excessive current leakage. Read the 0-100mA RMS scale.

**NOTE:** Most safety specifications set a limit of 70mA for this measurement. Refer to the appropriate specification (or equipment manufacturer) for the correct limit. Proceed only when burn hazard measurements are within acceptable limits.

6. Turn Function Select Switch to 10 MIU, **SHOCK HAZARD**.
7. Use Positive Test Lead to probe all accessible conductive surfaces and check for excessive current leakage. Read the 0-10 MIU scale. If measured current is less than 1/3 of full scale, increase meter sensitivity by turning the Function Select switch clockwise until pointer is in upper 2/3 of the dial.

**NOTE:** ANSI C101.1 limits current leakage to 0.5 MIU RMS for most appliances, but exceptions are allowed for unique situations. Refer to the equipment manufacturer's applicable safety standard for more details.

8. Repeat steps 3 through 7 for both positions of SW2 within 5 seconds of closing SW1. If the equipment has multiple separate conductive surfaces, repeat steps 3-8 as quickly as possible for each surface.
9. Continue monitoring leakage current, using the procedure outlined in steps 3-8 above, while equipment warms up and operates normally.
10. Open SW1 and monitor leakage current (using the procedure outlined in steps 3-8 above) until equipment cools or until leakage current stabilizes.

**NOTE:** If at any time during the test, the equipment under test exceeds the limits specified by the appropriate safety standard (or by the manufacturer), replace the equipment or remove it from service until the necessary repairs are complete.

## 8. MAINTENANCE AND CARE

---



This Instrument is constructed with high-quality components. Providing reasonable care and routine maintenance will ensure a long service life of trouble-free operation.

### 8.1 Service

---

The Model 228 Current Leakage Tester contains no operator-serviceable parts, except for the batteries and the fuse. Refer all service requests to an authorized service dealer or to the factory.

### 8.2 Battery Replacement

---

To install 9 volt NEDA type 1604A alkaline batteries:

1. Turn OFF the Instrument and disconnect the Instrument test leads before opening the battery compartment.
2. Place the Instrument face-down on a soft, padded surface.
3. Using a flat-blade screwdriver, loosen the large captive screw holding the battery compartment cover and remove cover.
4. Replace both batteries.





Whenever the Battery Check indicates low battery power, always replace both batteries.

5. Replace battery compartment cover.

### **8.3 Fuse Replacement**

---

To replace a blown fuse:

1. Turn OFF the Instrument and disconnect the Instrument test leads before opening the battery compartment.
2. Place the Instrument face-down on a soft, padded surface.
3. Using a flat-blade screwdriver, loosen the large captive screw holding the battery compartment cover. Remove cover.
4. Carefully remove the blown fuse and replace with fresh fuse.



Use a fuse of specified size and rating:

Size: 1/4" x 1-1/4"

Rating: 0.1A, 250V

Fuse is Littlefuse model 312.1 or equivalent and is available through electric supply sources.

5. Replace the battery compartment cover.

## **9. CARE OF INSTRUMENT**

---



Do not attempt to clean this Instrument with the test leads connected to a power source or when it is connected to the AC power line.

1. Immediately clean spilled materials from the Instrument and wipe dry. If necessary, moisten a cloth with soap and water to clean plastic surfaces.
2. Avoid exposing Instrument to temperature and humidity extremes, vibration, mechanical shock, dust, corrosive fumes, or strong electrical or electromagnetic interferences.
3. Verify Instrument calibration by performing operational checks using known value sources. For information on Instrument calibration, call Simpson Customer Service.
4. It is recommended that the Instrument be returned annually to the factory for inspection and calibration. Call Simpson Customer Service for instructions.
5. When not in use, store Instrument in a location free from temperature extremes, dust and corrosive fumes, mechanical vibration and shock.

## 10. RMS VS. PEAK

---

Throughout this manual there have been frequent notices about using the meter to measure sinusoidal currents only. These warnings are necessary because of the nature of leakage current and its effect on the body.

Almost all studies investigating electrical shock hazard have shown that the severity of an electric shock is more closely related to peak current than the average value or RMS value. As a result, the authors of IEC 990 decided that a peak reading Instrument was the best Instrument for measuring shock hazard. Measuring peak current can be a difficult task in a noisy environment or when the unit under test is producing high frequency signals. The ANSI C101.1 committee felt that this difficulty was a significant problem and specified an RMS reading Instrument for measuring leakage current.

The Model 228 attempts to resolve the differences in specifications by providing a direct reading RMS meter and by providing a buffered output for measuring peak current. The Instrument provides a peak reading scale on the dial as a convenience for users who have verified that a sinusoidal current is present.

The output on the Model 228 provides the user with the ability to measure the waveform that comes out of the measurement network.

When measuring non-sinusoidal currents, take precautions to insure that the peak levels of current do not overload the internal amplifiers in the meter. The simplest method of doing this is to connect a peak reading instrument to the Model 228 output. After identifying the appropriate range, select the next highest range and compare the reading. If the readings match (after adjusting for attenuator scale factor), then the amplifiers are not in overload, and the more sensitive range may be used. If the readings do not match, the Model 228 is overloaded, and a higher range must be used.

When high crest factors are present, the difference between the RMS and the peak readings may be substantial. In those cases, it may be advisable to base safety on the peak reading even though ANSI C101.1 calls for RMS.

When using the Model 228, it is important to use the correct measurement limits. Contact the appropriate safety agency or the equipment manufacturer to determine whether RMS or peak measurements are required.

## NOTES

**SIMPSON ELECTRIC COMPANY** 853 Dundee Avenue  
520 Simpson Avenue, Lac Du Flambeau, WI 54538-0099  
Elgin, IL 60120-3090 (847) 697-2260 FAX (847) 697-2272  
Printed in U.S.A. Part No. 06-115537 Edition 4, 7/04  
Visit us on the web at: [www.simpsonelectric.com](http://www.simpsonelectric.com)