

*Simpson*<sup>®</sup>

**Simpson 14510-2  
Volt-Ohm-Milliammeter  
OPERATOR'S MANUAL**

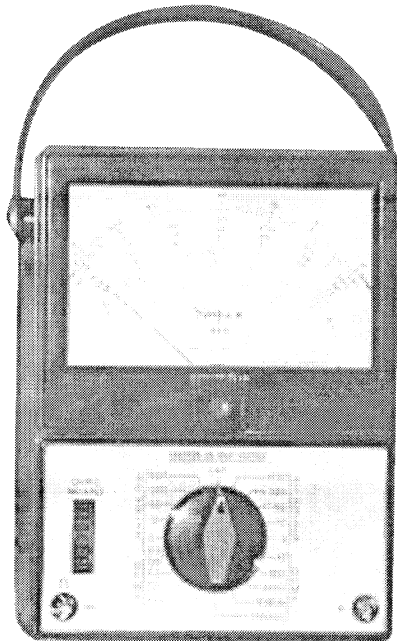

Courtesy of :  
[Simpson260.com](http://Simpson260.com)

### **About this Manual**

To the best of our knowledge and at the time written, the information contained in this document is technically correct and the procedures accurate and adequate to operate this instrument in compliance with its original advertised specifications.

### **Notes and Safety Information**

This Operator's Manual contains warning symbols which alert the user to check for hazardous conditions. These appear throughout this manual where applicable, and are defined below. To ensure the safety of operating performance of this instrument, these instructions must be adhered to.

 Warning, refer to accompanying documents.

 Caution, risk of electric shock.



This instrument is designed to prevent accidental shock to the operator when properly used. However, no engineering design can render safe an instrument which is used carelessly. Therefore, this manual must be read carefully and completely before making any measurements. Failure to follow directions can result in a serious or fatal accident.

### **Technical Assistance**

SIMPSON ELECTRIC COMPANY offers assistance Monday through Friday 7:30 am to 5:00 pm Central Time. To receive assistance contact Technical Support or Customer Service at (847) 697-2260.

Internet: <http://www.simpsonelectric.com>

### **Warranty and Returns**

SIMPSON ELECTRIC COMPANY warrants each instrument and other articles manufactured by it to be free from defects in material and workmanship under normal use and service, its obligation under this warranty being limited to making good at its factory or other article of equipment which shall within one (1) year after delivery of such instrument or other article of equipment to the original purchaser be returned intact to it, or to one of its authorized service centers, with transportation charges prepaid, and which its examination shall disclose to its satisfaction to have been thus defective; this warranty being expressly in lieu of all other warranties expressed or implied and of all other obligations or liabilities on its part, and SIMPSON ELECTRIC COMPANY neither assumes nor authorizes any other persons to assume for it any other liability in connection with the sales of its products.

**SHOCK HAZARD:** *As defined in American National Standard, C39.5, Safety Requirements for Electrical & Electronic Measuring & Controlling Instrumentation, a shock hazard shall be considered to exist at any part involving a potential in excess of 30 volts RMS (sine wave) or 42.4 volts DC or peak and where a leakage current from that part to ground exceeds 0.5 milliampere,*

*when measured with an appropriate measuring instrument defined in Section 11.6.1 of ANSI C39.5.*

**NOTE:** The proper measuring instrument for the measurement of leakage current consists essentially of a network of a 1500 ohm non-inductive resistor shunted by a 0.15 microfarad capacitor connected between the terminals of the measuring instrument. The leakage current is that portion of the current that flows through the resistor. The Simpson Model 229-Series 2 AC Leakage Current Tester meets the ANSI C39.5 requirements for the measurement of AC leakage current and can be used for this purpose. To measure DC Leakage current, connect a 1500 ohm non-inductive resistor in series with a Simpson 0-500 DC microammeter and use this as the measuring instrument.

Multi-function instruments such as the 14510-2 are intended as general purpose measuring instruments for use in relatively low power 120/240 V AC or dry battery operated circuits such as found in consumer appliances, home entertainment equipment or general laboratory applications. Some high power circuits, however, are within its measurement range and present an arcing/explosion hazard in the event of an unanticipated circuit behavior, a defective measuring instrument or of an operator error if the operator has not recognized the hazard and observed appropriate personal protective measures. Such high power circuits that would be within the measuring range of this Instrument would be found in commercial or industrial equipment operating from AC and DC supply circuits above 240 V, storage battery banks, or circuits containing large capacitors. Measurements in such circuits should only be performed by personnel trained to recognize the hazards and using appropriate safety measures. The Safety Precautions in Section IV are intended to alert the operator to the more commonly encountered hazards and protective measures to avoid them. The dangers in high power circuits are serious. Do not take safety precautions lightly.

**NOTE:** Any circuit containing voltages exceeding 30 V AC or 60 V DC should be considered to be a possible shock hazard, and contact with the circuit should be avoided while the circuit is energized.

## NOTES

## NOTES

# Contents

1. INTRODUCTION .....	7
1.1 General .....	7
1.2 Description .....	7
1.3 Items And Accessories .....	7
1.4 Technical Data .....	8
1.5 Definition Of Accuracy .....	9
1.6 Safety Consideration .....	9
2. PREPARATION FOR USE .....	10
2.1 Unpacking And Inspection .....	10
2.2 Warranty .....	10
2.3 Shipping .....	10
2.4 Power Source Requirements .....	10
3. CONTROLS, JACKS AND INDICATOR .....	11
3.1 Front Panel .....	11
4. OPERATION .....	12
4.1 Safety Precautions .....	12
4.2 Measuring DC Voltages .....	14
4.3 Measuring AC Voltages .....	14
4.4 Measuring Direct Current .....	15
4.5 Measuring Resistances .....	16
5. OPERATOR MAINTENANCE .....	17
5.1 Inspection .....	17
5.2 Battery And Fuse Access .....	17
5.3 Battery Replacement .....	18
5.4 Fuse Replacement .....	18
5.5 Care .....	19
6. SERVICING INSTRUCTIONS .....	20
6.1 Replacement Part Table for 14510-2 .....	20
6.2 Schematic Diagram, 14510-2 Volt-Ohm-Milliammeter .....	22

# 1. INTRODUCTION

---

## 1.1 General

---

The Simpson 14510-2 Volt-Ohm-Milliammeter (hereinafter referred to as the 14510-2 or the Instrument) is a portable instrument, suitable for the telephone industries. This instrument is designed for the service person who values true portability, reliability, simplicity and ruggedness. The Instrument can be applied in both permanent and mobile installations.

The 14510-2 features reverse safety-style jacks, an easy-to-read dial, a large range switch knob and an attractive color clutter-free panel.

## 1.2 Description

---

The case is made of high-impact (ABS) plastic and is contemporarily styled. The Instrument is battery operated for the resistance ranges, and fuse and diode overload protected, with a self-shielded taut-band movement. The taut-band suspension provides a high degree of repeatability and is highly resistant to shock and vibrations helping to ensure the accuracy and life of the Instrument. A handle, attached to the sides of the case, allows the Instrument to be used in either a vertical or horizontal position. The horizontal position is preferred for greater accuracy since the Instrument is calibrated in that position.

## 1.3 Items And Accessories

---

All applicable items and accessories required to operate the 14510-2 are furnished with the Instrument and are listed in Table 1-1. Additional accessories are listed in Table 1-2. Available replacement parts are listed in Table 6-1.

*Table 1-1. Accessories furnished with the Instrument*

Quantity	Description	Number
1	Test Lead Set	00043
*2	15 Volt Cell, NEDA 208	1-111010
*1	1.5 Volt, D Cell, NEDA 13F	1-111798
1	Operator's Manual	6-114022

\* Readily available through local retail stores.

*Table 1-2. Additional Accessories*

Description	Number
Utility Vinyl Carrying Case	00549
Vinyl Carrying Case	01818
Ever-Redy Vinyl Carrying Case	00805
Deluxe Carrying Case	00812

There are three batteries in the ohmmeter circuits. One is a NEDA 13F cell that furnishes 1.5 volts for the RX1, RX10, RX100 and RX1000 ranges. Two are NEDA 208 cells that furnish 30 volts required for the RX10,000 range. The batteries are readily available and replacement is accomplished easily. Most of the component parts are mounted on a printed circuit board which

simplifies assembly and maintenance, thus extending the useful life of the Instrument.

Each Instrument is furnished with one pair of probe type test leads (one red and one black, each 48 inches long, Catalog No. 00043) for all Instrument applications. These test leads have elbow plugs on one end to connect the leads to the recessed jacks on the Instrument front panel. The probe tips at the opposite end have threaded shoulders to accept the screw-on insulated alligator clips (furnished with the test leads). The test leads and the insulated alligator clips are rated for the voltage and current ranges available on the 14510-2. Maximum ratings are 100 V AC or DC or 10 DC amperes.



These ratings for the test leads must not be exceeded in any application.

## 1.4 Technical Data

Table 1-3 lists the Technical Data for the 14510-2

Table 1-3

### 1. DC VOLTS

**Ranges:** 0.3 V, 3 V, 12 V, 60 V, 300 V, 600 V

**Sensitivity:** 20 k $\Omega$ /volt ranges except on the 0.3 V range, 16 k $\Omega$ /volt.

**Accuracy:**  $\pm 2\%$  of full scale (FS) all ranges, except on the 0.3 V range, which on the 0.275 V mark (red line) is  $\pm 0.5\%$  of FS.

### 2. AC VOLTS

Range	Frequency Response (Hz)	Accuracy % of FS
3 V	20 Hz - 100 kHz $\pm 1\%$	$\pm 3$
12 V	20 Hz - 100 kHz $\pm 1\%$	$\pm 3$
60 V	20 Hz - 40 kHz $\pm 1\%$	$\pm 3$
300 V	20 Hz - 10 kHz $\pm 2\%$	$\pm 3$
600 V	20 Hz - 5 kHz $\pm 1\%$	$\pm 3$

**Sensitivity:** 3 k $\Omega$ /volt

**Indication:** Full wave average responding. Calibrated in rms for sinusoidal wave forms.

### 3. DC CURRENT

Range	Accuracy % of FS	Voltage Drop
0.06 mA	$\pm 2$	300 mV $\pm 2\%$
1.2 mA	$\pm 2$	149 mV nominal
12 mA	$\pm 2$	166 mV nominal
120 mA	$\pm 2$	341 mV nominal



#### 4. RESISTANCE

Range	Midscale Reading	Battery Voltage (Nominal)	Battery Current (Nominal)
RX1	20 $\Omega$	1.5 V	75 mA
RX10	200 $\Omega$	1.5 V	7.5 mA
RX100	2 k $\Omega$	1.5 V	0.75 mA
RX1000	20 k $\Omega$	1.5 V	0.075 mA
RX10,000	200 k $\Omega$	30 V	0.15 mA

Accuracy:  $\pm 2\%$  of FS angular deflection at midscale.

5. **Reference Conditions:** 25°C  $\pm 2^\circ\text{C}$ , 45 to 75% relative humidity
6. **Movement:** Taut-band 100° arc, 50  $\mu\text{A}$  FS
7. **Dial Arcs:** One arc each for  $\Omega$  and DC, two arcs for AC
8. **Overload Protection:** Meter movement by varistor, ranges fused 1/2 A, 250 V in series with 2 A, 600 V
9. **Operating Temperature Ranges (to maintain rated accuracy):** 57°F - 97°F
10. **Size:** 7" H x 4-1/4" W x 3-1/8" D
11. **Weight:** Approximately 2-1/2 lbs. with batteries (1.133 kg)
12. **Rated Circuit-to-Ground\*:** 600 V AC/DC maximum

\* Per ANSI C39.5 April 1974: "The maximum voltage, with respect to ground, which may safely and continuously be applied to the circuits of an instrument."

### 1.5 Definition Of Accuracy

---

The voltage and current accuracy of the Instrument is commonly expressed as a percent of full scale. This should not be confused with accuracy of reading (indication). For example,  $\pm 2\%$  of full scale on the 10 volt range allows an error of  $\pm 0.20$  V at any point on the dial. This means that at full scale, the accuracy of reading would be  $\pm 2\%$ , but at half scale it would be  $\pm 4\%$ . Therefore, it is advantageous to select a range which gives an indication as near as possible to full scale.

### 1.6 Safety Consideration

---

This Operator's Manual contains special caution and warning symbols to alert the user to hazardous operating and servicing conditions. These symbols appear throughout this publication where applicable and are defined on the inside front cover of this manual under SAFETY SYMBOLS. Adhere to these instructions in order to ensure the safety of operating and servicing personnel and to retain the operating performance of this Instrument.

## **2. PREPARATION FOR USE**

---

This section contains instructions for preparing the new Instrument for use. Also included are unpacking and inspection procedures, warranty, shipping, and power source requirements.

### **2.1 Unpacking And Inspection**

---

Examine the shipping carton for signs of damage before unpacking. If the carton is in good condition, unpack and inspect the Instrument and packing materials for possible damage incurred during shipment. If damage is noted, notify the carrier and supplier and do not attempt further use of the Instrument. If the Instrument appears to be in good condition, read the Operator's Manual in its entirety. Become familiar with the Instrument as instructed in the manual, then check the electrical performance. Also check to see that all furnished items and accessories are included (Table 1-1). Save the shipping carton and packing material for future storing or shipping of the Instrument.

After unpacking the Instrument, a 1.5 V battery and two 15 V batteries may be found in separate envelopes in the box with the Instrument and test leads. Two alligator clips for the test leads are in a polyethylene bag. (See Section 5 for instructions on how to open the battery compartment and install the batteries.)

### **2.2 Warranty**

---

The Simpson Electric Company warranty policy is printed on the inside front cover of this manual. Read it carefully before requesting any warranty repairs.

**NOTE:** For all assistance, including help with the Instrument under warranty, contact the nearest Authorized Service Center for instructions. If necessary, contact the factory directly. Give full details of any difficulty, the Instrument model number, series number and date of purchase. Service data or shipping instructions will be mailed promptly. If an estimate of charges for non-warranty or other service work is required, a maximum charge estimate will be quoted. This charge will not be exceeded without prior approval.

### **2.3 Shipping**

---

Pack the Instrument carefully and ship it prepaid and insured.

### **2.4 Power Source Requirements**

---

There are three batteries in the ohmmeter circuits. One is a NEDA 13F cell that furnishes 1.5 volts for all ranges except RX10,000 range. Two NEDA 208 cells furnish 30 volts for the RX10,000 range. Weak batteries should be replaced promptly. Replace with the same type batteries as supplied with the Instrument. (See Table 1-1.)

### 3. CONTROLS, JACKS AND INDICATOR

The purpose and use of the 14510-2 front panel controls and its features are described below. Become familiar with each control and its function before using the Instrument.

#### 3.1 Front Panel

Item numbers in Table 3-1 correspond with identifying numbers in Figure 3-1.

Table 3-1. Controls, Jacks and Indicator

- |                          |  |
|--------------------------|--|
| 1. <b>Meter:</b>         | This meter is calibrated for AC voltage (rms), DC voltage, current and resistance. Some scales are read directly while others require a multiplying factor.  |
| 2. <b>Range Switch:</b>  | The range switch has 21 positions. It may be turned to any position from either direction. There are eleven voltage positions, four direct current positions, five resistance positions and an OFF position.                                   |
| 3. <b>Ohms Adjust:</b>   | The ohms adjust control is a variable resistor in the ohmmeter circuit, which permits adjustment to "0" for the ohms ranges.   |
| 4. <b>Circuit Jacks:</b> | There are two jacks located on the front panel. These are the connections for the test leads. The elbow prods of the test leads are plugged into the proper jacks. Negative (-) black to ( $\Omega$ ) jack, positive (+) red lead to (+) jack. |

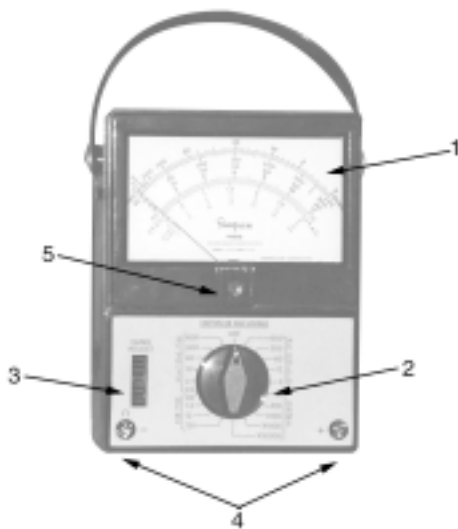

Figure 3-1. Simpson 14510-2 Front Panel

## 5. Pointer Adjust for Zero

With the Instrument in an operating position, check that the pointer indicates zero at the left end of the scale when there is no input. If pointer is off zero, adjust the screw located in the cover below the center of the dial. Use a small screwdriver to turn the screw slowly clockwise or counterclockwise until the pointer is exactly over the zero mark at the left end of the scale. With the indicating pointer set on the zero mark, reverse the direction of rotation of the zero adjuster a sufficient amount to introduce mechanical freedom or "play" but an insufficient amount to disturb the position of the indicating pointer. This procedure will avoid disturbances to the zero setting by subsequent changes in temperature, humidity, vibration and other environmental conditions.

## 4. OPERATION

---



Before attempting to operate this Instrument, refer to WARNING on inside front cover of this manual.

Information required to use and operate the 14510-2 in the proper manner follows below:

The test leads are provided with accessory screw-on alligator clips which may be attached to the probe tips. Eliminating the need to hand-hold test probes to a circuit for extended periods, the test clips also reduce hand proximity to a high voltage circuit while energized. Circuit power must, of course, be turned off and any charged capacitors discharged before connecting or disconnecting clips to or from the circuit. Replacement of test leads, when necessary, should be of the exact style supplied with the Instrument.

**NOTE:** All measurements are made with the black test lead connected to the ( $\Omega$ ) jack and the red test lead to the (+) jack.

Before making any measurements, check to see that the pointer indicates zero, when the Instrument is in the operating position. If the pointer is off zero, use a small screwdriver to turn the screw located directly above the range switch in either direction until the pointer rests at zero. (See Section 3, Controls, Jack and Indicator.)

### 4.1 Safety Precautions

---

**NOTE:** The following precautions are suggestions and reminders of commonly recognized safe practices to be used and specific hazards to be avoided and are not implied to be sufficient to ensure the safety of untrained personnel in all circumstances. Neither is this manual a substitute for technical manuals covering the equipment in which measurements are to be made. Always

refer to the equipment manual and its specific warnings and instructions, and observe them as well as those contained herein.

1. The 14510-2 should only be used by personnel qualified to recognize shock hazards and trained in the safety precautions required to avoid possible injury.
2. Do not connect any terminal of this Instrument to a circuit point at which a voltage exceeding 600 volts AC or DC may exist with respect to earth ground. (Refer to Table 1-3, item 12.)
3. This Instrument is intended only for use indoors or in sheltered locations. To prevent fire or shock hazards, do not expose it to rain or moisture. Condensation may occur when the Instrument is moved from a cold area to a warm area. **DO NOT ATTEMPT HIGH VOLTAGE MEASUREMENTS UNTIL CERTAIN THAT THE INSTRUMENT HAS DRIED THOROUGHLY.**
4. Turn off power and discharge any capacitors in the circuit to be measured before connecting to or disconnecting from it.
5. Before using this Instrument, check accessories (if any) and test leads for missing, damaged, deteriorated or otherwise faulty insulating parts. Do not use, or permit the use of, equipment with faulty insulation until it has been properly repaired.

**IMPORTANT:**

6. Always wear safety glasses when working with electrical circuitry.
7. Do not work alone on high voltage circuits. Make certain that someone capable of rendering aid is nearby and aware.
8. Do not handle the Instrument, its test leads or the circuitry while taking any measurements.
9. Be sure to reset the range switch to the OFF position after completing resistance or current measurements. This is to prevent inadvertent application of high voltage to the resistance or current ranges when the Instrument is next used.
10. Hands, shoes, floor and workbench must be dry. Avoid measurements under humid, damp or other environmental conditions that could affect the dielectric withstanding voltage of the test leads of the Instrument.
11. Do not change switch settings or test lead connections while the circuit is energized. A mistake could result in damage to the Instrument and possible personal injury.
12. Locate all voltage sources and accessible current paths before making connections to circuitry.

**NOTE:** Voltage may appear unexpectedly or in unexpected locations in faulty equipment. An open bleeder resistor, for example, may result in a capacitor retaining a dangerous charge.

13. Make certain that the equipment being worked upon is properly grounded and fuses are of the proper type and rating.
14. Check and double check switch positions and jack connections before applying power to the Instrument.
15. Always remain alert for low voltage circuits which may be floating at high voltage with respect to earth ground and for composite voltages (AC + DC) such as are found in rf amplifiers. The floating voltage or composite

voltage must not exceed the Instrument's rated maximum circuit-to-ground voltage. (See Table 1-3, item 12.)

16. Do not make electrical measurements where the air may contain explosive concentrations of gas or dust such as in mines, grain elevators, gas-line stations or in the presence of charging batteries, until determined to be safe by qualified personnel. Note that even metallic dust can be explosive.
17. No general purpose VOM is to be used to make measurements on blasting circuits or blasting caps. Use only designated instruments.



Be extremely careful when working with high voltage circuits. Even though the Instrument and test leads are well insulated for protection of the operator, it is not advisable to handle either when power is on in the circuit.

## 4.2 Measuring DC Voltages

---

1. Set the range switch at one of the six voltage range positions marked 0.3 V, 3 V, 12 V, 60 V, 300 V or 600 V. When in doubt about the approximate voltage present, start with the highest voltage range to protect the Instrument. If the voltage reading is within the limits of a lower range, the switch then may be set to that range to obtain a more accurate reading.
2. Be sure the power is off in the circuit to be measured and all capacitors have been discharged.
3. Connect the black test lead to the negative side of the circuit being measured and the red test lead to the positive side of the circuit.
4. Turn on the power of the circuit and read the voltage on the black scale marked AC-DC. For the 0.3 V and the 3 V ranges, use the 0-300 figures and divide the reading by 1000 and 100 respectively. For the 12 V, 60 V and 300 V ranges read the figures directly. For the 600 V range, use the 0-60 figures and multiply the reading by 10.
5. Turn the power off, disconnect the test leads and return the range switch to the OFF position.

## 4.3 Measuring AC Voltages

---

**NOTE:** The rectifier circuit in the 14510-2 responds to the full-wave rectified average value of an AC waveform. The Instrument is calibrated in terms of the rms value of a pure sine wave which will be correct for all sinusoidal waveforms. If the waveform is non-sinusoidal, the reading could result in a substantial error. Also, accuracy is lessened at higher input frequencies.

**NOTE:** Since the VOM will respond to DC voltage when set on any AC voltage range, an external blocking capacitor must be employed where measurements of AC superimposed on DC are encountered.

1. Set the range switch at one of the five voltage range positions marked 3 V, 12 V, 60 V, 300 V or 600 V. When in doubt about the approximate voltage in the circuit being measured, start with the highest voltage range as

a protection to the Instrument. If the voltage is within a lower range, the switch then may be set at a lower range to obtain a more accurate reading.

2. Be sure the power is off in the circuit being measured and all the capacitors have been discharged.
3. Connect the test lead across the voltage source with the black lead on the ground side.
4. Turn on the power in the circuit being measured and read the voltage on the red scale marked AC.
5. For the 3 V range, read the value directly on the red scale marked 3 V AC. For the 12 V, 60 V, 300 V and 600 V ranges, read on the black scale marked AC-DC. For the 12 V, 60 V and 300 V ranges, read the figures directly. For the 600 V range, use the 0-60 figures and multiply the reading by 10.
6. Turn power off, disconnect the test leads and return the range switch to the OFF position.

#### 4.4 Measuring Direct Current

---



Never connect the test leads of this Instrument directly across any source of voltage when it is used for current measurements. This will damage the Instrument.

**NOTE:** The voltage drop will not significantly affect most circuits whose current is being measured. In some low voltage circuits, such as transistor circuits, it may be necessary to take the voltage drop into account when making current measurements. (See Table 1-3, Current Ranges.)



Do not switch any range or function settings on the Instrument and never disconnect the test leads from the circuit while the circuit under measurement is energized. When the circuit is de-energized, discharge all the capacitors. Never exceed the circuit-to-ground voltage of the Instrument, 600 V max. (See Table 1-3, item 4.12.)



In all current measurements, be certain that the power to the circuit under test has been turned off before restoring circuit continuity.

1. Set the range switch at one of the four range positions marked 0.06 mA, 1.2 mA, 12 mA or 120 mA. Always start with the highest range first.
2. Turn the power off, discharge all capacitors and open the circuit in which the current is to be measured. Connect the Instrument in series with the circuit. Connect the red test lead to the positive side and the black test lead to the negative side of the circuit.
3. Turn on the power to the circuit under test.

4. Read the current in milliamperes on the black AC-DC scales. For the 0.06 mA range, use the 0-60 scale and divide the reading by 1000. For the 1.2 mA range, use the 0-12 scale and divide the reading by 10. For the 12 mA range, use 0-12 scale and read directly. For the 120 mA range, use 0-12 scale and multiply readings by 10.
5. Upon completion of all readings, turn off power to the circuit and remove test leads from circuit.
6. **IMPORTANT:** Return range switch to the OFF position when current measurements are completed.

## 4.5 Measuring Resistances

---



Before making resistance measurements, remove all power to the circuit under test and discharge all capacitors.

When DC resistances are measured, the internal batteries of the Instrument furnish power for the measuring circuit. The zero adjust control provides correction for battery deterioration over long periods of time.

1. Set the range switch to the desired resistance range position.
2. Connect the probe ends of the test leads together (short tips together).
3. Observe the Instrument indication. It should read "0" on the ohms arc, which is at the top of the dial.
4. If the pointer does not read "0", rotate the V Adj. (Zero Adjust Control) knob either direction until it does read "0". If the pointer cannot be brought up to the "0" mark, replace the appropriate battery (1.5 V for low ranges and two 15 V for the high range — refer to paragraph 5.3 for battery replacement).



Do not apply any power to the circuit before measurements are completed and the test leads are disconnected.

5. Connect the test leads across the resistance which is to be measured. If there is a "forward" and "backward" resistance, such as with diodes, observe the polarity in the lead connections to control each test. The resistance should be relatively low when the diode is forward biased by the battery potential and higher in the opposite direction.



When checking diodes and semiconductors do not use the RX1000 or RX10,000 ranges. Using these ranges may result in permanent damage to component being checked.

6. Read the indication of the OHMS arc at the top of the dial. Note that the arc reads from right to left for increasing values.
7. Multiply the reading by the multiplier factor indicated at the switch posi-



tion; the result is the resistance value in ohms. ("K" on the dial and panel stands for "one thousand.")

**NOTE:** The resistance of nonlinear components will measure differently from one resistance range to another. For example: a diode could measure 80 ohms on the RX1 range and 300 ohms on the RX10 range. The difference in the reading is a result of the non-linear diode characteristic and does not indicate faulty operation of the ohmmeter circuit.

8. Disconnect ends of test leads and return the range switch to the OFF position after resistance measurements are completed.

## 5. OPERATOR MAINTENANCE

---

This section describes those functions necessary to maintain the Instrument in an operating condition and which may be performed by the operator or user. This Instrument is carefully designed and constructed with high quality components. By providing reasonable care and following instructions in this manual, the user can expect a long, useful service life of the Instrument.

Servicing, other than that which is described in this Section, should be performed only by qualified personnel, by one of the Authorized Service Centers or by the factory.

### 5.1 Inspection

---

The user is protected from electrical shock by the insulation of the Instrument and the test leads. Frequent examination of each should be made for any insulation damage, such as cracks, cuts, chips, burns or deterioration that expose internal metal parts or conductors, or any reduction in spacing between such metal and hand contact by the user. Replacement leads should be the same as those originally supplied with the Instrument and can be obtained from one of the Authorized Service Centers or the factory.



To avoid electrical shock, disconnect test leads from live circuits and from the Instrument before opening the battery compartment cover.

### 5.2 Battery And Fuse Access

---

The batteries and 1/2-ampere fuse are located inside an isolated compartment at the top-rear of the Instrument case. To open the compartment, proceed as follows:

Place the Instrument face down on a soft padded surface and unscrew the single captivated screw on the compartment cover. Remove the cover from the case and set it aside. Batteries and fuse now can be replaced.

**NOTE:** If replacement of the 2-amp high current interrupting fuse is necessary, the Instrument case must also be removed (see paragraph 5.5 and Figure 5-2).

## 5.3 Battery Replacement

Battery replacement is indicated when the pointer cannot be adjusted to zero on a resistance range.

Remove the battery compartment cover (paragraph 5.3). If zero cannot be adjusted on the RX1, RX10, RX100 or RX1000 ranges, the 1.5 V battery needs replacement. Replace with a 1.5 V, NEDA 13F, "D" size cell. If zero cannot be

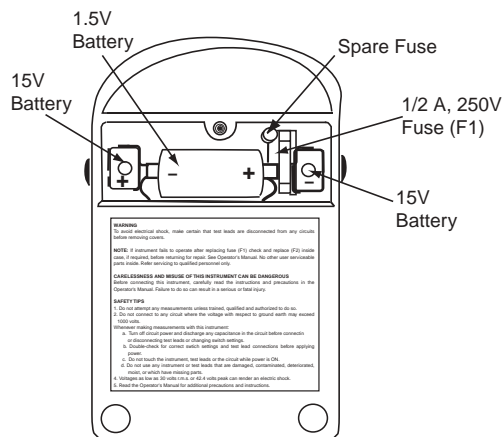

Figure 5-1. Battery and Fuse Compartment

adjusted on the RX10,000 range, one or both 15 V batteries need replacement. (It is suggested that both batteries be replaced at the same time.) Replace with 15 V NEDA 208 battery, Burgess U10, Eveready 411, Ray-O-Vac 208, or equivalent.

Replace the battery compartment cover.

## 5.4 Fuse Replacement

Fuse replacement is indicated when the Instrument is completely inoperative in all functions.

The 1/2 A, 250 V fuse is accessible inside the battery compartment. Remove the battery compartment cover (paragraph 5.3). Carefully pry the fuse from its clips and replace with an exact replacement. Do not substitute a different type fuse or rating. It may not serve its purpose and may cause the internal fuse to blow unnecessarily next time. Replace with a 1/2 A, 250 V Quick Acting Littlefuse Type 3AG, Catalog No. 312.500, or equivalent.

**NOTE:** A spare has been provided in the compartment adjacent to the working fuse as an emergency replacement. If the spare is used, replace it as soon as possible to assure that it will again be available in an emergency.

If the Instrument now operates (check it in a resistance range by shorting the test leads together), replace the compartment cover. If the Instrument still does not operate, the internal fuse may be open. For access to this fuse, the case back must be removed.

1. Remove the battery compartment cover. Place the Instrument face-down on a soft, padded surface. Loosen the four screws at the four corners of the case back and lift the case back off of the Instrument.

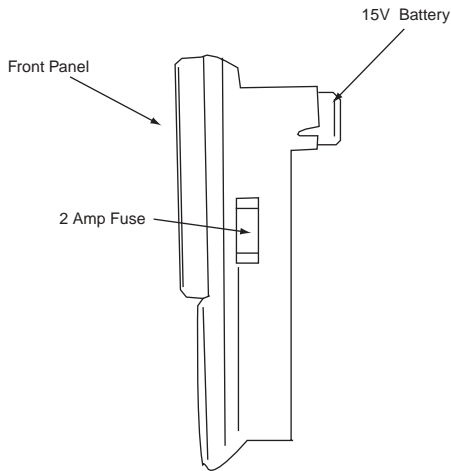

Figure 5-2. Location of 2 Amp Fuse



2. Take care not to disturb any internal components or wiring. Do not attempt any servicing beyond fuse replacement unless qualified to do so. Improper repairs may endanger the user of this Instrument. Refer to section 5, SERVICING INSTRUCTIONS.
3. Carefully pry the fuse from its clips and replace it with an exact replacement. Do not substitute a different type fuse or rating as it may not serve its special purpose. Replace only with a Littlefuse Type BLS or Bussman type BBS, 2 A, 600 V.
4. Shake the unit gently to make certain that no loose debris is left inside. Replace the case back and tighten the four screws. Replace the battery compartment cover.

## 5.5 Care

1. For insulation to remain effective, keep clean and dry at all times. For normal grime, use a mild detergent and a damp cloth to clean the Instrument and dry thoroughly before use. DO NOT PERMIT LIQUIDS TO ENTER THE CASE.
2. Immediately clean all spilled materials from the surface of the Instrument and wipe dry. If the spillage is corrosive, use a suitable cleaner to neutralize the corrosive action.
3. When the Instrument is not in use, rotate the function switch to the OFF position.
4. Whenever possible, avoid prolonged exposure or usage in areas which

are subject to temperature and humidity extremes, vibration or mechanical shock, dust or corrosive fumes, or strong electrical or electromagnetic interferences.

5. On a monthly basis, verify Instrument accuracy by performing operational checks using known, accurate and stable sources. If proper calibration equipment is not available, contact the nearest Authorized Service Center. If the Instrument has not been used for 30 days, check the batteries for leakage and replace if necessary.
6. It is recommended that the Instrument be returned annually to the nearest Authorized Service Center, or to the factory for an overall check, adjustment and calibration.
7. When the Instrument is not in use, store in a room free from temperature extremes, dust, corrosive fumes and mechanical vibration or shock. If storage time is expected to exceed 30 days, remove batteries.



8. When an Instrument must be stored and/or transported in a vehicle in very cold weather, it will be subject to condensation when brought into a warm building. Therefore, do not attempt high voltage measurements until the Instrument has had time to dry completely.

## 6. SERVICING INSTRUCTIONS

An improperly repaired instrument may be dangerous to the user. This Instrument contains no user-serviceable parts other than the batteries and fuses. Do not attempt any other repairs or parts replacement unless trained and qualified to do so. The contents of this section are provided only for use by such qualified repairmen. Refer repairs to the factory or to one of the Authorized Service Centers.

Table 6-1 lists the replacement parts for the 14510-2 and the ordering part numbers. Replacement parts and accessory items may be ordered from the factory or from any Authorized Service Center.

### 6.1 Replacement Part Table for 14510-2

*Table 6.1. Replacement Parts for 14510-2*

Symbol	Description	Part No.
B1, B2	15 V Battery	1-111010
B3	1.5 V Battery	1-111798
D1, D2	Diode, Germanium, 1N100	1-115970
R2	Resistor, 27 k $\Omega$ , 1%, 1/2 W	1-110282
R3	Rheostat, 100 k $\Omega$ , 10%, 1/2 W	5-119020
R4, R5	Rheostat, 1 k $\Omega$ , 10%, 1.5 W, W.W.	5-117967
R6	Resistor, 1.3 $\Omega$ V, 1%, 1/2 W	5-118990
R9	Rheostat, 2 k $\Omega$ , 10%, 1.5 W, W.W.	5-116716
R10	Resistor, 4.5 k $\Omega$ , 1%, 1/2 W	5-118983
R11	Resistor, 27 k $\Omega$ , 1%, 1/2 W	1-110282

Table 6.1. Replacement Parts for 14510-2 (Continued)

Symbol	Description	Part No.
R12	Resistor, 171 k $\Omega$ , 1%, 1/2 W	1-110283
R13	Resistor, 891, k $\Omega$ , 1%, 1/2 W	5-118991
R14	Resistor, 1.79 M $\Omega$ , 1% 1/2 W	1-110285
R15	Potentiometer, 20 k $\Omega$ , 20%, 0.2 W	6-114010
R16	Resistor, 3 k $\Omega$ , 5%, 1/2 W	5-118682
R17	Resistor, 18 $\Omega$ , 1%, 1/2 W	1-118878
R18	Resistor, 180 $\Omega$ , 1%, 1/2 W	1-110274
R19	Resistor, 2.05 k $\Omega$ , 1%, 1/2 W	1-110273
R20	Resistor, 191 k $\Omega$ , 1%, 1/2 W	1-110291
R21	Resistor, 16 k $\Omega$ , 1%, 1/2 W	1-113348
R22	Resistor, 18.2 $\Omega$ , 1%, 1/2 W	1-110476
R23	Resistor, 184 $\Omega$ , 1%, 1/2 W	1-110271
R24	Resistor, 2.02 k $\Omega$ , 1%, 1/2 W	1-110270
R25	Resistor, 16.8 k $\Omega$ , 1%, 1/2 W	1-110292
R26	Resistor, 1.21 $\Omega$ , 1/2%, Bobbin	10-675499
R27	Resistor, 12.22 $\Omega$ , 1/2%, Bobbin	10-675201
R28	Resistor, 127 $\Omega$ , 1%, 1/2 W	1-117947
R29	Resistor 14.6 k $\Omega$ , 1/2%, 1/2 W	1-110290
R30	Rehostat, 300 $\Omega$ , 10%, 1.5 W	5-118984
R31	Resistor, 2.4 k $\Omega$ , 1%, 1/2 W	1-116331
R32	Resistor, 57 k $\Omega$ , 1%, 1/2 W	1-110288
R33	Resistor, 237 k $\Omega$ , 1%, 1/2 W	1-110287
R34	Resistor, 1.2 M $\Omega$ , 1%, 1/2 W	1-119147
R35, R36	Resistor, 6 M $\Omega$ , 1%, 1W	1-110286
F1	Fuse 1/2 amp, 250 V, 3AG, Quick Acting	1-113233
F2	Fuse, 2 amp, 600 volts, Littlefuse Type	
	BLS or Bussman Type BBS	5-119056
	Range Switch, Knob	6-113341

Figure 6-1. Schematic Diagram 14510-2 on Page 22

6.2 Schematic Diagram, 14510-2 Volt-Ohm-Milliammeter

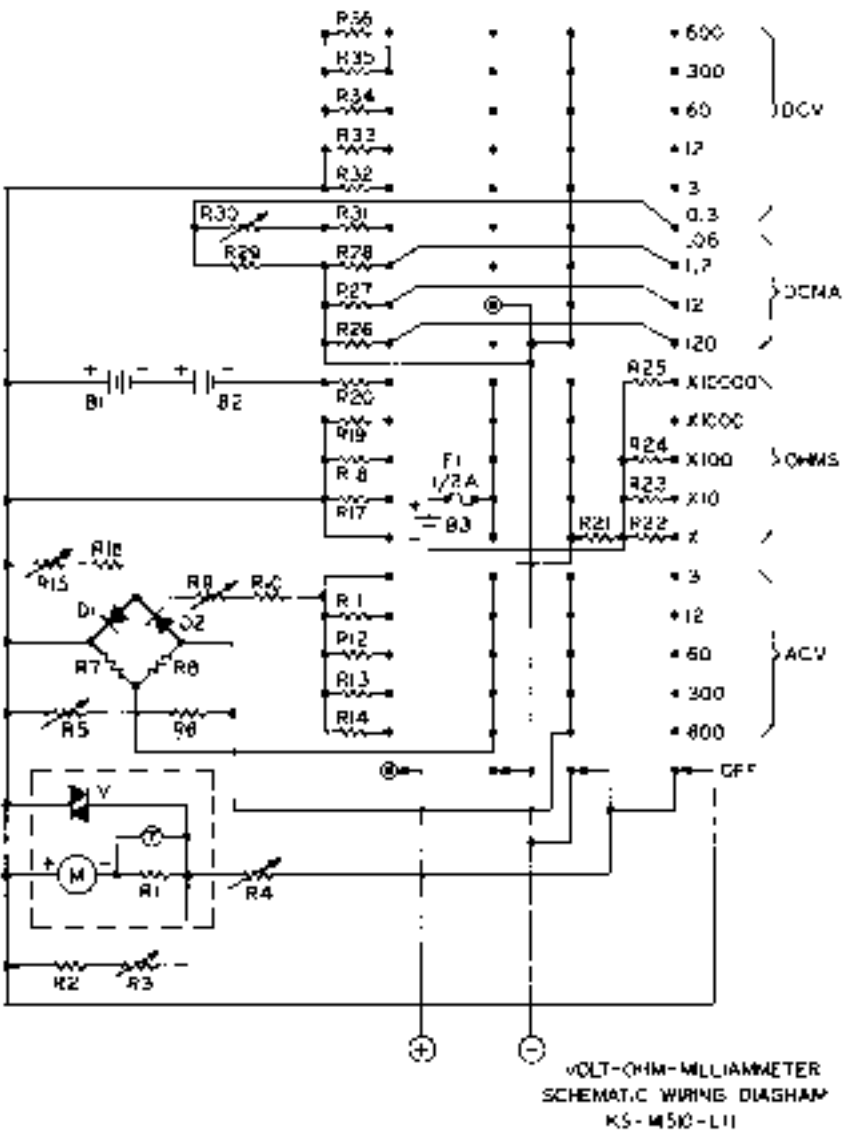

Figure 6-1. Schematic Diagram 14510-2 Volt-Ohm-Milliammeter

## NOTES

**SIMPSON ELECTRIC COMPANY** 853 Dundee Avenue  
Elgin, IL 60120-3090 (847) 697-2260 FAX (847) 697-2272  
Printed in U.S.A. Part No. 06-114022 Edition 3, 11/02  
Visit us on the web at: [www.simpsonelectric.com](http://www.simpsonelectric.com)