

## Warranty

SIMPSON ELECTRIC COMPANY warrants each instrument and other articles of equipment manufactured by it to be free from defects in material and workmanship under normal use and service, its obligation under this warranty being limited to making good at its factory any instrument or other article of equipment which shall within 90 days after delivery of such instrument or other article of equipment to the original purchaser be returned intact to it, or to one of its authorized service stations, with transportation charges prepaid, and which its examination shall disclose to its satisfaction to have been thus defective; this warranty being expressly in lieu of all other warranties expressed or implied and of all other obligations or liabilities on its part, and SIMPSON ELECTRIC COMPANY neither assumes nor authorizes any other persons to assume for it any other liability in connection with the sale of its products.

This warranty shall not apply to any instrument or other article of equipment which shall have been repaired or altered outside the SIMPSON ELECTRIC COMPANY factory or authorized service stations, nor which has been subject to misuse, negligence or accident, incorrect wiring by others, or installation or use not in accord with instructions furnished by the manufacturer.



**SIMPSON ELECTRIC COMPANY**  
853 Dundas Ave. E. Unit. Bhamo-60120 Phone: (312) 697-2260  
**IN CANADA** Bach Simpson, Ltd., London, Ontario  
**IN ENGLAND** Bach Simpson (U.K.) Ltd., Walsbridge, Cornwall  
**IN INDIA** Hutchins/Simpson Private, Ltd., International House, Bombay Area



# OPERATOR'S MANUAL

## SIMPSON 270 SERIES 5 VOLT-OHM-MILLIAMMETER

Courtesy of :  
[Simpson260.com](http://Simpson260.com)



This symbol on the nameplate means the product is Listed by Underwriters Laboratories, Inc., #9244



Printed in U.S.A.  
5C581 (123.03)  
EFFECTIVE DATE: 1283  
EDITION: 3rd

Part No. 6-111642

## TABLE OF CONTENTS

### SECTION I

<b>Introduction</b> .....	1-1
1.1 General .....	1-1
1.2 Description .....	1-2
1.3 Internal Batteries .....	1-3
1.4 Printed Circuit .....	1-3
1.5 Phenolic Case .....	1-3
1.6 Adjust-A-Vue Handle .....	1-4
1.7 Test Leads .....	1-4
1.8 Technical Data .....	1-5
1.9 Definition of Accuracy .....	1-7
1.10 Safety Considerations .....	1-7

### SECTION II

<b>Installation</b> .....	2-1
2.1 General .....	2-1
2.2 Unpacking and Inspection .....	2-1
2.3 Warranty .....	2-1
2.4 Shipping .....	2-2
2.5 Power Source Requirements .....	2-2
2.6 Operating Position .....	2-2

### SECTION III

<b>Controls, Jacks, and Indicators</b> .....	3-1
3.1 General .....	3-1
3.2 Front Panel Description .....	3-1

### SECTION IV

<b>Operation</b> .....	4-1
4.1 General .....	4-1
4.2 Safety Precautions .....	4-1
4.3 Polarity Reversing .....	4-3
4.4 Measurement of Unknown Voltage or Current ..	4-4
4.5 Test Leads .....	4-4

## Table of Contents

4.6 DC Voltage Measurement 0-250 mV Range .....	4-4
4.7 DC Voltage Measurement 0-1V Range .....	4-5
4.8 DC Voltage Measurement 0-2.5 Through 0-500V Range .....	4-7
4.9 DC Voltage Measurement 0-1000V Range .....	4-8
4.10 AC Voltage Measurement 0-2.5 Through 0-500V Range .....	4-10
4.11 AC Voltage Measurement 0-1000V Range .....	4-12
4.12 Output Voltage Measurement .....	4-13
4.13 Decibel Measurements (-20 to +50 dB) .....	4-15
4.14 Direct Current Measurement .....	4-18
4.15 Direct Current Measurement 0-50 $\mu$ A Range .....	4-18
4.16 Direct Current Measurement 0-1 mA Through 0-500 mA Range .....	4-20
4.17 Direct Current Measurement 0-10A Range .....	4-21
4.18 Resistance Measurements .....	4-22
4.19 Measuring Resistance .....	4-22
4.20 Resistance Measurement of Semiconductors .....	4-24

### SECTION V

<b>Operator Servicing</b> .....	5-1
5.1 General .....	5-1
5.2 Inspection .....	5-1
5.3 Battery Replacement .....	5-1
5.4 Fuse Replacement .....	5-2
5.5 Test Lead Inspection .....	5-4
5.6 Care .....	5-4

## Table of Contents

### SECTION VI

<b>Servicing Instructions</b> .....	6-1
6.1 General .....	6-1
6.2 Removing the Instrument Case .....	6-1
6.3 Replacement Parts and Schematic Diagram .....	6-1

### LIST OF TABLES

1-1 Technical Data .....	1-5
1-2 Items and Accessories Furnished With This Instrument .....	1-8
1-3 Additional Accessories .....	1-8
3-1 Controls, Jacks, and Indicators .....	3-1
6-1 Replacement Parts .....	6-2

### LIST OF ILLUSTRATIONS

1-1 Simpson 270-5 Volt-Ohm-Milliammeter .....	vii
3-1 Front Panel Controls, Jacks, and Indicators .....	3-2
4-1 Jacks and Switch Positions For Measuring DC Voltage .....	4-6
4-2 Frequency Response, AC Voltage Ranges .....	4-9
4-3 Jacks and Switch Positions For Measuring AC Voltage .....	4-11
4-4 Frequency Response Output Ranges .....	4-14
4-5 Jacks and Switch Positions For Output Measurement .....	4-16
4-6 Jacks and Switch Positions For Measuring Decibels .....	4-17

## Table of Contents

4-7 Jacks and Switch Positions For Measuring Direct Current .....	4-19
4-8 Jacks and Switch Positions For Measuring Resistance .....	4-23
5-1 Battery and Fuse Compartment .....	5-3
6-1 Schematic Diagram .....	6-4

---

**NOTE:** This Operator's Manual contains information essential to the operation of this Instrument. Therefore, it should be kept with the Instrument at all times and not misplaced or discarded. See "Notes for the Record" at the back of this Manual.

## SAFETY SYMBOLS



This marking adjacent to another marking or a terminal or operating device indicates that the operator must refer to an explanation in the Operating Instructions to avoid damage to the equipment and/or to avoid personal injury.

### WARNING

The WARNING sign denotes a hazard. It calls attention to a procedure, practice or the like, which if not correctly performed or adhered to, could result in personal injury.

### CAUTION

The CAUTION sign denotes a hazard. It calls attention to a procedure, practice or the like, which if not correctly adhered to could result in damage to or destruction of part or all of the Instrument.

### 1000 v max

This marking advises the user that the terminal(s) so marked must not be connected to a circuit point at which the voltage, with respect to earth ground, exceeds (in this case) 1000 volts.

### WARNING

**This Instrument is designed to prevent accidental shock to the operator when properly used. However, no engineering design can render safe an instrument which is used carelessly. Therefore, this manual must be read carefully and completely before making any measurements. Failure to follow directions can result in a serious or fatal accident.**

**SHOCK HAZARD:** As defined in American National Standard, C39.5, Safety Requirements for Electrical & Electronic Measuring & Controlling Instrumentation, a shock hazard shall be considered to exist at any part involving a potential in excess of 30 volts rms (sine wave) or 42.4 volts DC or peak and where a leakage current from that part to ground exceeds 0.5 milliamper, when measured with an appropriate measuring instrument defined in Section 11.6.1 of ANSI C39.5.

**NOTE:** The proper measuring instrument for the measurement of leakage current consists essentially of a network of a 1500 ohm non-inductive resistor shunted by a 0.15 microfarad capacitor connected between the terminals of the measuring instrument. The leakage current is that portion of the current that flows through the resistor. The Simpson Model 229-Series 2 AC Leakage Current Tester meets the ANSI C39.5 requirements for the measurement of AC leakage current and can be used for this purpose. To measure DC Leakage current, connect a 1500 ohm non-inductive resistor in series with a Simpson 0-500 DC microammeter and use this as the measuring instrument.

## SECTION I INTRODUCTION

### 1.1 GENERAL

1.1.1 The Simpson Volt-Ohm-Milliammeter 270 Series 5 is a rugged, accurate, compact, easy-to-use instrument which can be used to make accurate measurements of AC and DC voltage, direct current, resistance, decibels, and Output Voltage. The Output Voltage function is used for measuring the AC component of a mixture of AC and DC voltage. This occurs primarily in amplifier circuits.

### 1.1.2 New Features for the 270 are:

- New connectors between the Instrument and the test leads which eliminates a shock hazard in the event a connector is inadvertently pulled out of the Instrument jack.
- A high energy fuse  $F_2$  which is now in the BATTERY AND FUSE COMPARTMENT, and accessible without removing the Instrument case.
- An OFF/TRANSIT position which has been added to the function switch to protect the meter movement during transit. (This position shunts the meter movement and opens the internal connections to the COMMON and + jacks.)
- A test lead set with molded elbow plugs at one end for connection to the front panel input terminals and test probes at the other end. The test probes have a non-slip grip surface and a barrier to maintain the spacing between the user's fingers and the probe tip. Threaded shoulders at the probe tip accept screw-on alligator clips (supplied) or an accessory AC or DC 5000 volt range extending probes.

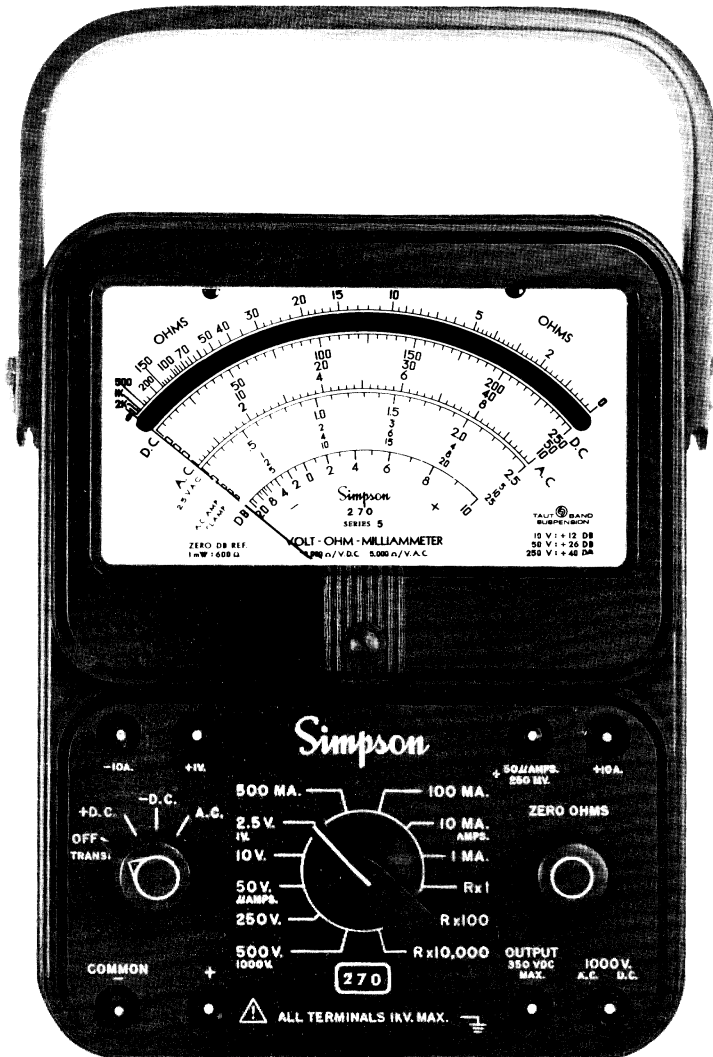

FIGURE 1-1. SIMPSON 270-5 VOLT-OHM-MILLIAMMETER

## Introduction

### 1.2 DESCRIPTION

#### 1.2.1 Overload Protection

**1.2.2** No single protective device nor even a combination of devices as found in the 270 can fully protect a multi-purpose instrument under all overload conditions. Overloads of such severity as to damage the Instrument despite all the built-in protection provided are possible when the Instrument is misused. The fuse/varistor combination in the 270 has been designed to afford maximum instrument protection under foreseeable overload conditions which might occur within the measuring capabilities of the Instrument; however, the operator must exercise care to avoid severe overloads, particularly when working in high voltage circuits.

- a. Fuses: Basic overload protection is provided by a small inexpensive and easily obtainable 3 AG type, 1 ampere, quick-blow fuse. This fuse is rated to interrupt circuit voltages up to 250 volts. A supplemental high energy fuse is provided for additional protection from severe overloads. This fuse is the Bussman Type BBS 2A 600 V and has an interruption capacity of 10,000 amps AC. The Littelfuse Type BLS 2A 600 V with an interrupt capacity of 100,000 amps AC may also be used.
- b. For maximum protection it is important to replace the 1A fuse with the Littelfuse type 312001 only. This will allow the combination of 1A and 2A fuse to give maximum protection to the unit and the user under overload conditions which may occur within the measuring capability of the VOM.
- c. If the Instrument fails to indicate, the 1 Amp or the 2 Amp fuse may be burned out. (Refer to paragraph 5.4 for fuse replacement.) A 1 Amp spare fuse is furnished with each

## Introduction

Instrument. Fuses are located in the battery and fuse compartment.

NOTE: The 0-10A range is not fused. The shunt connects directly to the -10A and +10A jacks.

- d. Varistor Protection: A varistor connected across the meter movement affords protection to the movement by circumventing excessive current around the movement in the event of an overload.

### 1.3 INTERNAL BATTERIES

**1.3.1** There are two batteries in the ohmmeter circuits. One is a NEDA 13F size D cell that furnishes 1.5-volts for the R x 1 and R x 100 ranges. A NEDA 1604 battery furnishes 9-volts for the R x 10,000 range.

### 1.4 PRINTED CIRCUIT

**1.4.1** Most of the component parts are mounted on a printed circuit board which simplifies assembly and maintenance, thus, extending the useful life of the Instrument.

### 1.5 PHENOLIC CASE:

- The phenolic case is designed with heavy reinforced walls for maximum durability and provides excellent protection for the circuit components.
- The case has an externally accessible battery and fuse compartment. Access to the batteries and fuses is obtained by unscrew-

## Introduction

ing a single captivated screw at the bottom of the case and sliding out the compartment cover.

- Rubber plug bumpers on the bottom of the case reduce sliding should the 270 be accidentally pulled by the test leads when the instrument is on a workbench.

### 1.6 ADJUST-A-VUE HANDLE

**1.6.1** A carrying handle is attached to the Instrument case. The handle may be used to support the Instrument in a convenient sloping position for easy viewing. The case can also be placed in either a vertical or horizontal position. The horizontal position is preferable for greater accuracy since the Instrument is calibrated in this position.

### 1.7 TEST LEADS

**1.7.1** Each Instrument is furnished with one pair (Catalog Number 00043) of probe type test leads (one red and one black, each 48 inches long) for all applications of the Instrument. These test leads have elbow prods on one end, to connect the leads to the recessed jacks on the Instrument front panel. The probe tips at the opposite end have threaded shoulders to accept the screw-on insulated alligator clips (furnished with the test leads) or the 5000 volt test probe(s) to extend the Instrument AC or DC voltage range. The test leads and the insulated alligator clips are rated for the voltage and current ranges available on the 270. Maximum ratings are 1000V AC or DC or 10 DC amperes. **These ratings for the test leads must not be exceeded in any application.**

## Introduction

### 1.8 TECHNICAL DATA

**1.8.1** Table 1-1 lists the technical data for the 270.

**TABLE 1-1. TECHNICAL DATA**

1. DC VOLTS:	
Ranges:	0-1-2.5-10-50-250-500-1000V
Sensitivity:	20,000 ohms per volt
2. DC MILLIVOLTS:	
Range:	0-250mV
Sensitivity:	20,000 ohms per volt
3. AC VOLTS:	
Ranges:	0-2.5-10-50-250-500-1000V
Sensitivity:	5,000 ohms per volt
4. OUTPUT VOLTAGE (AC):	
Ranges:	0-2.5-10-50-250 (limited to 350 VDC)
5. DC MICROAMPERES:	
Range:	0-50 $\mu$ A
Voltage Drop:	250 mV
6. DC MILLIAMPERES:	
Ranges:	0-1-10-100-500 mA
Voltage Drop (Approx.):	250 mV, 255 mV, 300mV 500 mV
7. DC AMPERES:	
Range:	0-10A
Voltage Drop (Approx.):	255 mV

NOTE: The 10A range is **not** internally fused.

### Introduction

8. RESISTANCE:	R × 1	R × 100	R × 10,000
Range	0-2,000Ω	0-200,000Ω	0-20 MΩ
Center Reading	12Ω	1200Ω	120,000Ω
Nominal Open Circuit Voltage	1.5V	1.5V	9V
Nominal Short Circuit Current	125 mA	1.25 mA	75μA

### 9. \*ACCURACY:

	77°F.	67°-87°F
DC Voltage Ranges:	1.25% of Full Scale	1.75% of Full Scale
DC Current		
0-50μA Range:	.75% of Full Scale	1.25% of Full Scale
Other Ranges:	1.25% of Full Scale	1.75% of Full Scale
**AC Voltage Ranges:	2% of Full Scale	3% of Full Scale
Frequency Response:	Referenced to 100Hz (Figures 4-2 and 4-4)	
Resistance Ranges:		
R × 1:	1.5% of Arc	1.75° of Arc
R × 100:	1° of Arc	1.25° of Arc
R × 10,000:	1° of Arc	1.25° of Arc

10. DECIBELS: —20 to +10 dB, —8 to +22dB,  
Range: +6 to +36 dB, +20 to +50 dB  
Reference Level: With zero dB power level equal to  
1 mW across a 600Ω line.

### 11. BATTERIES:

Voltage: 1.5V, 9V  
NEDA No.: 13F, 1604

12. FUSE: F1 1A, 250V, type 3AG, quick-acting Littelfuse Type 312001,  
F2 2A, 600 V (Bussman Type BBS or Littelfuse Type BLS)

### Introduction

13. TEST LEADS: 1 red, 1 black, 48" long.
14. SIZE: 5½" x 7" x 3⅛" (13.34 x 17.78 x 7.94 cm)
15. WEIGHT: 3 lbs. (1.359 kg)
16. \*\*\*RATED-CIRCUIT TO-GROUND VOLTAGE: 1000V AC/DC Max.

\* Accuracies specified are for the 270 in a horizontal position.

\*\* Responds to the average value of an AC current, and is calibrated to indicate the rms value of a pure sine wave.

\*\*\* Per ANSI C39.5 April 1974: "The maximum voltage, with respect to Ground, which may safely and continuously be applied to the circuit of an Instrument."

## 1.9 DEFINITION OF ACCURACY

**1.9.1** The voltage and current accuracy of this Instrument is commonly expressed as a percent of full scale. This should not be confused with accuracy of reading (indication). For example, +2% of full scale on the 10 volt range allows an error of ±0.20V at any point on the dial. This means that at full scale, the accuracy of reading would be ±2%, but at half scale it would be ±4%. Therefore, it is advantageous to select a range which gives an indication as near as possible to full scale.

## 1.10 SAFETY CONSIDERATIONS

**1.10.1** This Operator's Manual contains special caution and warning headings which alert the user to hazardous operating and servicing conditions. These headings appear throughout this publication,



## Introduction

where applicable, and are defined at the front of this manual under SAFETY SYMBOLS. To ensure the safety of operating and servicing personnel and to retain the operating conditions of the Instrument, these instructions must be adhered to.

**TABLE 1-2. ITEMS AND ACCESSORIES FURNISHED WITH THIS INSTRUMENT**

Quantity	Description	Number
1	Test Lead Set—one red and one black (4 ft. long) each with combination probe tip and removable rubber-sleeved alligator clip.	00043
*1	1.5 volt, D Cell, NEDA 13F	
*1	9.0 volt Cell, NEDA 1604	
2	1 Amp, 250 V Fuse, Littelfuse Type #312001	
1	2 Amp Fuse, 600 V (Bussman Type BBS or Littelfuse Type BLS)	
1	Operator's Manual	6-111642

\*Batteries are standard items replaceable from local retail stores.

**TABLE 1-3. ADDITIONAL ACCESSORIES**

Description	Catalog No.
Deluxe Case . . . . .	00812
Vinyl Sheath Case . . . . .	01818
Leatherette Ever-Ready Hard Case, Drop Front . . . . .	00805
5,000 Volts AC Probe 5 k $\Omega$ /V, Used with 00043 Test Leads . . . . .	00794
5,000 Volts DC Probe 20 k $\Omega$ /V, Used with 00043 Test Leads . . . . .	00795
10,000 Volts AC Probe 5 k $\Omega$ /V . . . . .	00413
10,000 Volts DC Probe 20 k $\Omega$ /V . . . . .	00412
40,000 Volts DC 20 k $\Omega$ /V . . . . .	00411
Low-Power ohm probe . . . . .	00414
Model 150-2 Amp-Clamp . . . . .	00545
Model 151-2 Line Splitter . . . . .	00544

## Introduction

### PROBES

#### High Voltage Probes

High voltage probes and test prod adapters provide a convenient and economical means of extending the voltage range of the 270-5. They are intended for high voltage measurements in low power, consumer type products such as TV receivers, oscilloscopes, burner ignition systems and the like. They are **not** intended for and should **not** be used for measurements in high power circuitry such as power substations or distribution centers, induction r-f heaters or broadcast transmitters, X-ray equipment or the like where an operator error may create a dangerous condition.

#### Accessory DC High Voltage Probes

The DC high voltage probes are designed for use with the Simpson 270-5 or any 20,000 ohms per volt VOM having a 2.5 volt DC range and scale graduations from 0-10 or multiple thereof for the 10 kV probe, 0-50 or multiple thereof for the 40 kV probe.

Accuracy: Probe Resistance  $\pm 2\%$ .

The high voltage test probes are available at local electronic parts distributors.

#### Accessory AC High Voltage Probe

The 10,000 volts AC accessory probe is similar to the high voltage DC probes with the following exceptions: The AC high voltage probe is designed to extend the 270-5 AC voltage range. The probe can be used with the Simpson 270-5 10-volt AC range.

NOTE: Instructions are furnished with each high voltage probe.

## Introduction

### AMP-CLAMP MODEL 150-2

The Simpson Amp-Clamp Model 150-2 allows AC current measurements without breaking the circuit under test. The Amp-Clamp works in effect as a transformer containing a split core for accommodating the conductor which carries the current being measured.

The current carrying conductor becomes the transformer primary and a coil in the Amp-Clamp serves as the secondary winding. The Amp-Clamp output voltage is proportional to the current measured and can be applied to the 270-5 as an AC voltage.

The Amp-Clamp has a range selector with 6 positions. Any of the following current ranges can be used with the 270-5:

5, 10, 25, 50, 100 or 250 amperes.

NOTE: Instructions are furnished with each Amp-Clamp.

## SECTION II INSTALLATION

### 2.1 GENERAL

**2.1.1** This section contains information and instructions for the installation and shipping of the Simpson 270-5. Included are unpacking and inspection procedures, warranty, shipping, power source requirements and operating position.

### 2.2 UNPACKING AND INSPECTION

**2.2.1** Examine the shipping carton for obvious signs of damage. If damage is noted, notify the carrier and supplier and do not attempt further use of the Instrument. If Instrument appears to be in good condition, read Operator's Manual in its entirety. Become familiar with the Instrument as instructed in the manual, then proceed to check the electrical performance as soon as possible. Also, check that all items are included with the Instrument (Table 1-2).

**2.2.2** After unpacking the Instrument, a 1.5V battery and a 9V battery may be found in separate envelopes in the box with the Instrument and test leads. Two alligator clips for the test leads are in a polyethylene bag. (See Section V for instructions on how to open the battery compartment and install the batteries.)

### 2.3 WARRANTY

**2.3.1** The Simpson Electric Company warranty policy is printed on the inside front cover of this manual. Read it carefully prior to requesting any warranty repairs.

## Installation

NOTE: For assistance of any kind, including help with the Instrument under warranty, contact the nearest Authorized Service Center for instructions (listed on the last pages of this manual). If it is necessary to contact the factory directly, give full details of any difficulty and include the Instrument model number, series number, and date of purchase. Service data or shipping instructions will be mailed promptly. If an estimate of charges for non-warranty or other service work is required, a maximum charge estimate will be quoted. This charge will not be exceeded without prior approval.

### 2.4 SHIPPING

**2.4.1** Pack the Instrument carefully and ship it prepaid and insured to the proper destination.

### 2.5 POWER SOURCE REQUIREMENTS

**2.5.1** There are two batteries in the ohmmeter circuits. One is a NEDA 13F D size cell that furnishes 1.5 volts for the  $R \times 1$  and  $R \times 100$  ranges. A NEDA 1604 battery furnishes 9 volts for the  $R \times 10,000$  range. The 1.5 D cell is held in place with two spring clips which also serve as battery contacts. The 9-volt battery is held in place with a spring clip but contact is made with a separate connector that is polarized. (Always observe correct polarity when replacing the 1.5-volt D cell.)

### 2.6 OPERATING POSITION

**2.6.1** A handle is attached to the side of the Instrument case. The handle may be used to support the Instrument in a convenient,

## Installation

sloping position for easy viewing. The 270 can also be placed either in a vertical or horizontal position. The horizontal position is preferable for greater accuracy since the Instrument is calibrated in this position.

---

## SECTION III CONTROLS, JACKS, AND INDICATORS

### Controls, Jacks and Indicators

#### 3.1 GENERAL

**3.1.2** All operating and adjustment controls, jacks and indicators for the Simpson 270-5 are described in this section along with a list (Table 3-1) describing their function. Become familiar with each item prior to operating the Instrument.

#### 3.2 FRONT PANEL DESCRIPTION

**3.2.1** Description of front panel controls, jacks, and indicators is as follows:

NOTE: The items called out in Figure 3-1, correspond with the numerical order of the items listed in Table 3-1.

**TABLE 3-1. CONTROLS, JACKS, AND INDICATORS**

- |                            |  |
|----------------------------|--|
| <b>1. Front Panel:</b>     | The 270-5 Volt-Ohm-Milliammeter is a large, easy-to-read 4¼ inch indicating Instrument. Below the Instrument are three controls and eight circuit jacks. Switch positions and circuit jacks are marked in white characters for easy reading.   |
| <b>2. Range Switch:</b>    | Has 12-positions: May be turned in either direction. There are 5-voltage positions, 4-direct current positions, and three resistance positions used to select desired ranges.  |
| <b>3. Function Switch:</b> | The function switch has four positions: Off/Transit, +DC, —DC and AC. To measure DC current or voltage, set the function switch at the —DC or +DC position, depending on the polarity of the signal applied across the test leads. To measure AC voltage set the function switch to the AC position. For resistance measurement, the switch may be set in either the +DC or —DC position. The polarity of the internal |



**FIGURE 3-1. FRONT PANEL CONTROLS, JACKS AND INDICATORS**

## Controls, Jacks and Indicators

ohm-meter battery voltage at the (+) pos jack is identical to the function switch polarity setting and opposite at the (—) common jack.

**Off/Transit Position:** This function switch position opens the 270 common and + jack inputs to avoid accidental instrument overload or internal battery drain. Additionally it shunts the sensitive instrument during transit to provide damping during non-use periods.

4. **Zero Ohms:** This control is used to compensate for variation in the voltage of the internal batteries.
5. **Circuit Jacks:** There are eight jacks on the front panel marked with the functions they represent (Figure 3-1). These jacks provide the electrical connections to the test leads. The COMMON (—) jack is used (in conjunction with the black test lead) as the reference point for the measurement of all the functions with the exception of the 10A range. (Refer to the Operation Section for details.)
6. **Pointer Adjust For Zero:** With the Volt-Ohm-Milliammeter in an operating position, check that the pointer indicates zero at the left end of the scale when there is no input. If pointer is off zero, adjust the screw located in the cover below the center of the dial. Use a small screwdriver to turn the screw slowly clockwise or counterclockwise until the pointer is exactly over the zero mark at the left end of the scale. With the indicating pointer set on the zero mark, reverse the direction of rotation of the zero adjuster. Rotate the zero adjuster a sufficient amount to introduce mechanical freedom or "play" but insufficient to disturb the position of the indicating pointer. This procedure will avoid disturbances to the zero setting by subsequent changes in temperature, humidity, vibration, and other environmental conditions.

## SECTION IV OPERATION

### WARNING

**Multi-function Instruments (VOM's) such as the 270-5 are intended as general purpose measuring instruments for use in low power circuitry such as found in consumer appliances, TV and radio receivers, and in general laboratory applications. Their use is not recommended in high voltage, high power circuitry where operator errors and inadequate personal protective measures could result in serious injury from arcing or explosion. Such circuitry is found in industrial or commercial applications such as induction (r-f) heaters and broadcast transmitters, power substations and distribution centers, X-ray equipment, large motor controls and the like. Working in the high voltage section of such equipment requires single-function, often specially designed instruments used by specially trained personnel using appropriate protective equipment and procedures.**

### 4.1 GENERAL

**4.1.1** This section of the manual contains information required to use and operate the 270-5 in a safe and proper manner.

### 4.2 SAFETY PRECAUTIONS

**NOTE:** The following precautions are suggestions and reminders of commonly recognized safe practices and specific hazards to be avoided and are not implied to be sufficient to ensure the safety of untrained personnel in all circumstances. Neither is this manual a substitute for technical manuals covering the equipment in which measurements are to be made. Always refer to the equipment manual and its specific warnings and

## Operation

instructions and observe them as well as those contained herein.

- 4.2.1** The 270 should only be used by personnel qualified to recognize shock hazards and trained in the safety precautions required to avoid possible injury.
- 4.2.2** Do not connect any terminal of this Instrument to a circuit point at which a voltage exceeding 1000 volts AC or DC may exist with respect to earth ground. (Refer to Table 1-1, item 16.)
- 4.2.3** Turn off power and discharge any capacitors in the circuit to be measured before connecting to or disconnecting from it.
- 4.2.4** Prior to using this Instrument, check accessories (if any) and test leads for missing, damaged, deteriorated or otherwise faulty insulating parts. Do not use, or permit the use of equipment with faulty insulation until it has been properly repaired.

- NOTE: • Always wear safety glasses when working in electrical circuitry.
- Do not work alone on high voltage circuits. Make certain that someone capable of rendering aid is nearby and watchful.
  - Do not handle the instrument, its test leads, or the circuitry while high voltage is being applied.

- 4.2.5** Hands, shoes, floor, and workbench must be dry. Avoid making measurements under humid, damp, or other environmental conditions that could affect the dielectric withstanding voltage of the test leads or Instrument.
- 4.2.6** Do not change switch settings or test lead connections while the circuit is energized. A mistake could result in damage

## Operation

to the instrument and possible personal injury.

- 4.2.7** Locate all voltage sources and accessible current paths before making connections to circuitry.

**REMEMBER:** Voltage may appear unexpectedly or in unexpected locations in faulty equipment. An open bleeder resistor, for example, may result in a capacitor retaining a dangerous charge.

- 4.2.8** Make certain that the equipment being worked upon is properly grounded and fuses are of the proper type and rating.
- 4.2.9** Check and double check switch positions and jack connections before applying power to the Instrument.
- 4.2.10** Always remain alert for low voltage circuits which may be floating at high voltage with respect to earth ground and for composite voltages (AC + DC) such as are found in r-f amplifiers. The floating voltage or composite voltage must not exceed the Instruments rated maximum circuit-to-ground voltage.
- 4.2.11** Do not make electrical measurements where the air may contain explosive concentrations of gas or dust such as in mines, grain elevators, gasoline stations or in the presence of charging batteries until determined to be safe by qualified personnel. Note that even metallic dusts can be explosive.

## 4.3 POLARITY REVERSING

- 4.3.1** The function switch provides a convenient means to reverse polarity of the internal battery to facilitate testing semiconductor devices. The +DC and -DC positions transpose internal connections to the COMMON and + jacks and therefore can also be used to reverse polarity of external voltages and currents connected

## Operation

to these jacks (only). Because polarity reversing momentarily interrupts the circuit, it should not be done while measuring current without first turning off the circuit power. When making measurements on the 50 $\mu$ A/250mV, 1 volt, or 10 amp range, polarity can be corrected only by interchanging the test lead connector to the current.

### 4.4 MEASUREMENT OF UNKNOWN VOLTAGE OR CURRENT

**4.4.1** Sometimes the approximate voltage or current to be measured is known and the correct range may easily be selected. It is often the case, however, particularly when working upon faulty equipment, when the voltage or current is either unknown or may be much higher than normal and anticipated. Whenever working upon unfamiliar or unknown equipment, always begin a measurement using the highest range available on the Instrument. Once it is determined that the voltage is within the limits of a lower range, change to the lower range.

### 4.5 TEST LEADS

**4.5.1** These are provided with accessory screw-on alligator clips which may be attached to the probe tips. Aside from the convenience of eliminating the need to hand-hold test prods to a circuit for extended periods, the test clips provide a means of reducing hand proximity to a high voltage circuit while energized. Circuit power must of course be turned off and any charged capacitors discharged before connecting or disconnecting clips to or from the circuit.

### 4.6 DC VOLTAGE MEASUREMENT 0-250 mV RANGE

NOTE: For polarity reversing see paragraph 4.3.

## Operation

### CAUTION

**Prior to making voltage measurements, review the SAFETY PRECAUTIONS listed in paragraph 4.2. Also, when using the 270 as a millivoltmeter, care must be taken to prevent damage to the indicating instrument from excessive voltage. Before using the 250 millivolt range, use the 1.0-volt DC range to determine that the voltage measured is not greater than 250 millivolts (or .25 volt DC).**

- Set the function switch at +DC (Figure 4-1).
- Plug the black test lead in the — COMMON jack and the red test lead into the +50  $\mu$ AMPS/250mV jack.
- Set the range switch at 50  $\mu$ AMPS (COMMON) position with 50V.
- Connect the black test lead to the negative side of the circuit being measured and the red test lead to the positive side of the circuit.
- Read the voltage on the black scale marked DC and use the figures marked 0-250. Read directly in millivolts.

**NOTE: For polarity reversing see paragraph 4.3.**

### 4.7 DC VOLTAGE MEASUREMENT 0-1V RANGE

- Set the function switch at +DC (Figure 4-1).
- Plug the black test lead into the — COMMON jack and the red test lead into the +1V jack.

## Operation

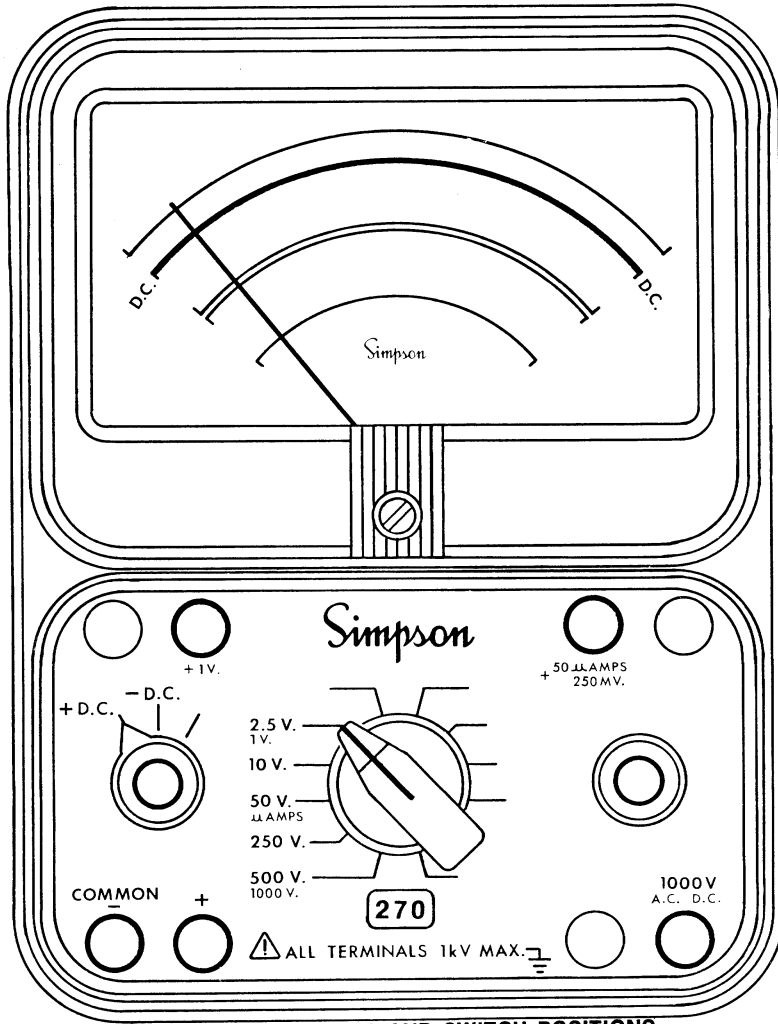

FIGURE 4-1. JACKS AND SWITCH POSITIONS FOR MEASURING DC VOLTAGE

## Operation

- Set the range switch at 1V (COMMON position with 2.5V).
- Connect the black test lead to the negative side of the circuit being measured and the red test lead to the positive side of the circuit.
- Read the voltage on the black scale marked DC and use the figures marked 0-10. Then divide the reading by 10.

**NOTE:** For polarity reversing see paragraph 4.3.

### 4.8 DC VOLTAGE MEASUREMENT 0-2.5 THROUGH 0-500V RANGE

- Set the function switch at +DC (Figure 4-1).
- Plug the black test lead into the - COMMON jack and the red test lead into the + jack.
- Set the range switch at one of the five voltage range positions marked 2.5V, 10V, 50V, 250V or 500V.

**NOTE:** When in doubt as to the voltage present, always use the highest voltage range as a protection to the Instrument. If the voltage is within a lower range, the switch may be set for the lower range to obtain a more accurate reading.

### IMPORTANT

**BE SURE POWER IS OFF IN THE CIRCUIT BEING MEASURED AND ALL CAPACITORS DISCHARGED.**

- Connect the black test lead to the negative side of the circuit being measured and the red test lead to the positive side of the circuit.
- Turn on the power in the circuit being measured.
- Read the voltage on the black scale marked DC. For the 2.5V range, use the 0-250 figures and divide by 100. For the 10V,



## Operation

50V, and 250V ranges, read the figures directly. For the 500V range, use the 0-50 figures and multiply by 10.

NOTE: Turn off power to the circuit and wait until the meter indicates zero before disconnecting the test leads.

### 4.9 DC VOLTAGE MEASUREMENT 0-1000V RANGE

#### WARNING

Be extremely careful when working with high voltage circuits. Do not touch the Instrument or test leads while power is on in the circuit being measured.

4.9.1 Before proceeding with the following steps, review the Safety Precautions in Paragraph 4.2.

- Set the function switch at +DC (Figure 4-1).
- Set the range switch at 1000V (dual position with 500V).
- Plug the black test lead into the - COMMON jack and the red test lead into the 1000V jack.
- Be sure power is off in the circuit being measured and all capacitors discharged. Connect the black test lead to the negative side of the circuit being measured and the red test lead to the positive side of the circuit.
- Turn on power in circuit being measured.
- Read the voltage using the 0-10 figures on the black scale marked DC. Multiply the reading by 100.

NOTE: Turn off power to the circuit and wait until the meter indicates zero before disconnecting the test leads.

## Operation

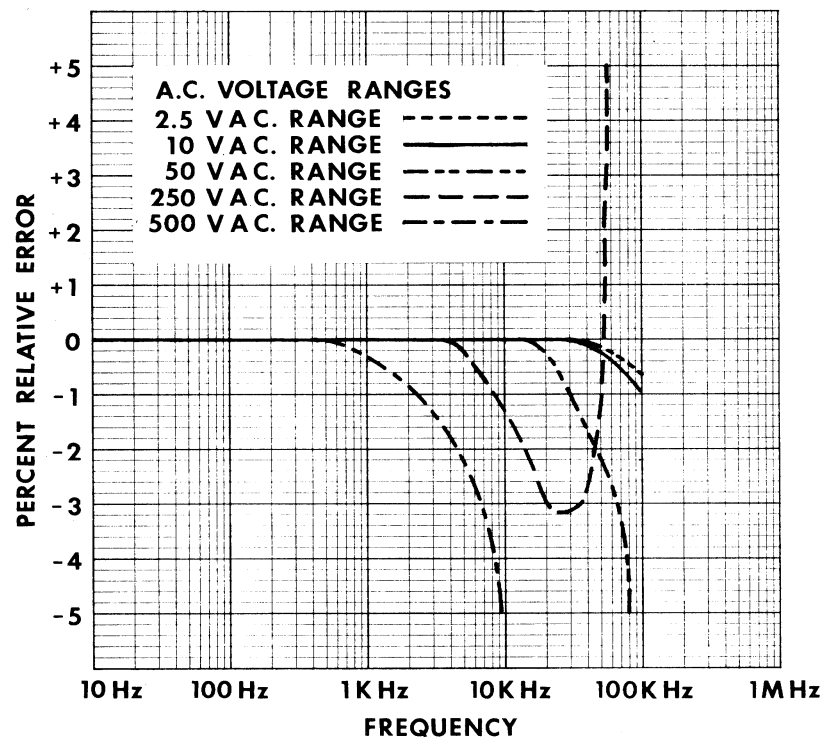

FIGURE 4-2. FREQUENCY RESPONSE, AC VOLTAGE RANGES

## Operation

### 4.10 AC VOLTAGE MEASUREMENT 0-2.5 THROUGH 0-500V RANGE

#### WARNING

Branch and distribution circuits (120/240/480V etc.) can deliver dangerous explosive power momentarily into a short circuit before the fuse/breaker opens the circuit. Make absolutely certain that the Instrument switches are set correctly, jacks properly connected, and that the circuit power is turned off before making connections to such circuits.

**4.10.1** The 270 responds to the average value of an AC waveform. The Dial is calibrated in terms of the rms value of a pure sine wave. If the waveform is nonsinusoidal, and depending upon its waveform, the reading may be either higher or lower than the true rms value of the measured voltage. Thus an error may be introduced if the 270 is used to measure a nonsinusoidal waveform. Also, accuracy is lessened at higher input frequencies (Figure 4-2).

**4.10.2** Before proceeding with the following steps, review the Safety Precautions in Paragraph 4.2.

- Set the function switch at AC (Figure 4-3).
- Set the range switch at one of the five voltage range positions marked 2.5V, 10V, 50V, 250V or 500V.

**NOTE:** When in doubt as to actual voltage present, always use the highest voltage range as a protection to the Instrument. If the voltage is within a lower range, the switch may be set for the lower range to obtain a more accurate reading.

- Plug the black test lead into the – COMMON jack and the red test lead into the + jack.

## Operation

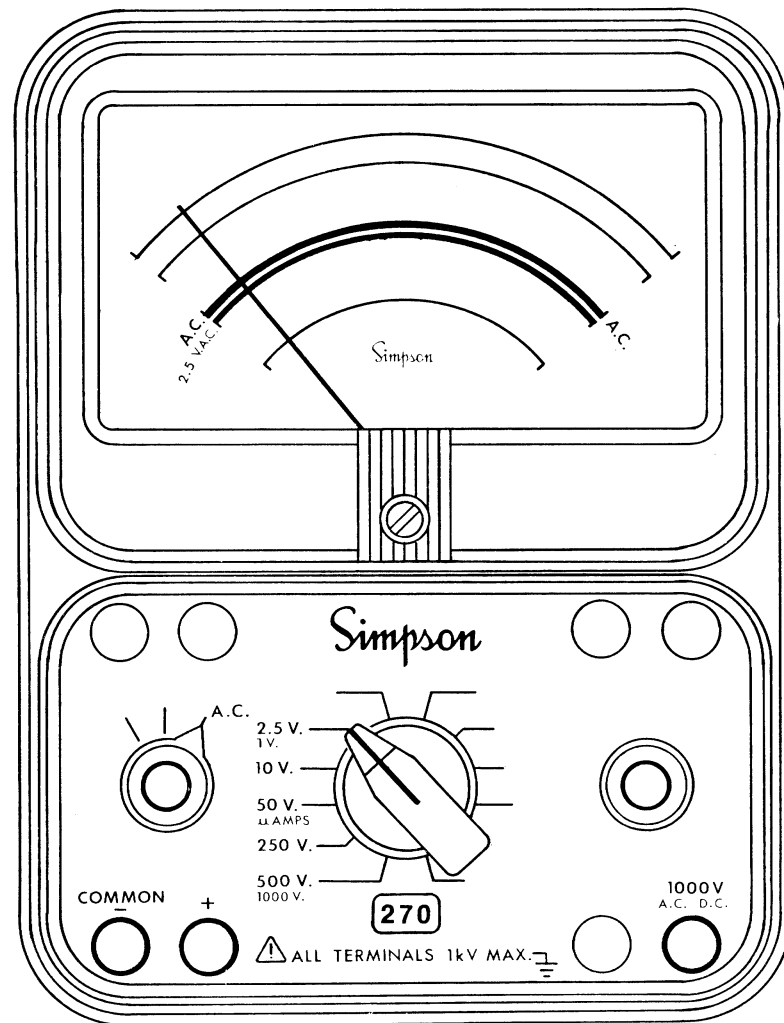

FIGURE 4-3. JACKS AND SWITCH POSITIONS FOR MEASURING AC VOLTAGE

## Operation

- d. Turn off power to the circuit to be measured and discharge any capacitors.
- e. Connect the test leads across the circuit voltage to be measured with the black lead to the grounded side.
- f. Turn power on.
- g. For the 2.5V range read the value directly on the scale marked 2.5 VAC. For the 10V, 50V, and 250V ranges, read the red scale marked AC and use the black figure immediately above the scale. For the 500V range, read the red scale marked AC and use the 0-50 figures. Multiply the reading by 10.

NOTE: Turn off power to the circuit and wait until the meter indicates zero before disconnecting the test leads.

### 4.11 AC VOLTAGE MEASUREMENT 0-1000V RANGE

#### WARNING

- **Be extremely careful when working in high voltage circuits. Do not handle the instrument or test leads while the circuit being measured is energized. OBSERVE ALL SAFETY PRECAUTIONS in paragraph 4.2 and in the instruction manual for the equipment being tested.**
  - **Do not attempt any circuit-to-ground voltage measurement which may exceed 1000 volts.**
  - **Be sure that the range switch is set to the 500V/1000V range, function switch to AC position, and test leads connected to common and 1000V jack.**
  - **Do not touch the instrument or test leads while the power is on in the circuit being measured.**
- a. Set the function switch at AC (Figure 4-3).
  - b. Set the range switch at 500/1000V position.

## Operation

- c. Plug the black test lead into the — COMMON jack and the red test lead in the **1000V jack**.
- d. Be sure the power is off in the circuit being measured and that all its capacitors have been discharged.
- e. Connect the test leads across the circuit voltage to be measured with the black lead to the grounded side, if any.
- f. Turn on the power in the circuit being measured.
- g. Read the voltage on the red scale marked AC. Use the 0-10 figures and multiply by 100.

NOTE: Turn off power to the circuit and wait until the meter indicates zero before disconnecting the test leads.

### 4.12 OUTPUT VOLTAGE MEASUREMENT

**4.12.1** It is often desired to measure the AC component of an Output Voltage where both AC and DC voltage levels exist. This occurs primarily in amplifier circuits. The 270 has a 0.1 mfd, 400 volt capacitor in series with the OUTPUT jack. The capacitor blocks the DC component of the current in the test circuit, but allows the AC or desired component to pass on to the indicating instrument circuit. The blocking capacitor may alter the AC response at low frequencies but is usually ignored at audio frequencies (Figure 4-4).

#### CAUTION

**Do not connect the OUTPUT jack to a circuit in which the DC voltage component exceeds 350V.**

- 4.12.2** Before proceeding with the following steps, review the Safety Precautions in Paragraph 4.2.
- a. Set the function switch at AC (Figure 4-5).
  - b. Plug the black test lead into the — COMMON jack and the red test lead into the OUTPUT jack.
  - c. Set the range switch at one of the range positions marked 2.5V, 10V, 50V, or 250V.

## Operation

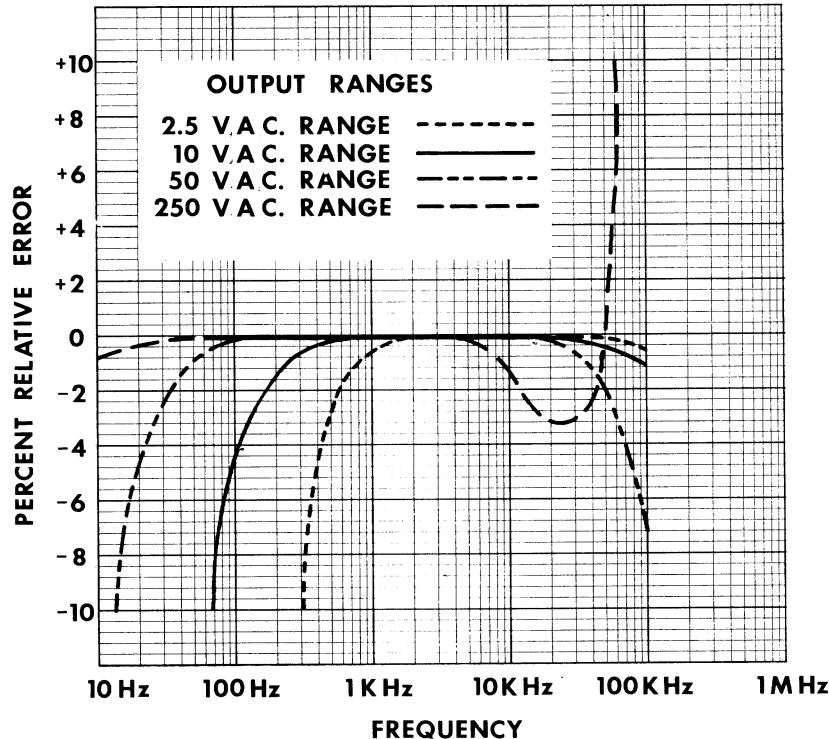

FIGURE 4-4. FREQUENCY RESPONSE OUTPUT RANGES

## Operation

- d. Turn power OFF.
- e. Connect the test leads across the circuit being measured with the black test lead to the ground side.
- f. Turn on the power in the test circuit. Read the output voltage on the appropriate AC voltage scale. For the 0-2.5V range, read the value directly on the scale marked 2.5 VAC. For the 10V, 50V, or 250V ranges, use the red scale marked AC and read the black figures immediately above the scale.

### 4.13 DECIBEL MEASUREMENT (-20 to +50 dB)

**4.13.1** In some industries, measurements are made in terms of voltage or current ratios (decibels) based on a specific reference level. The dB scale on the 270 serves this purpose and is calibrated to a reference level (zero dB) of 0.001 watt into 600 ohms. The scale calibration of -20 to +10 dB is for the 0-2.5V range (zero dB = 0.775V). Higher ranges may be used by adding an appropriate dB value to the reading in accordance with the chart below.

- a. Review the safety precautions in paragraph 4.2.
- b. Refer to Figure 4-6 for switch settings and jack connections.
- c. Use operating instructions for AC VOLTAGE MEASUREMENT, 0-2.5/10/50/250/500V RANGES (paragraph 4.10).  
**Do not use the 500V range for decibel readings.**
- d. Read decibels on the bottom scale marked dB. For the 10/50/250V ranges, add the appropriate factor from the chart below:

Voltage Range	dB Range	Reading
0- 2.5V	-20 to +10	read directly
0- 10 V	- 8 to +22	add +12 dB to reading
0- 50 V	+ 6 to +36	add +26 dB to reading
0-250 V	+20 to +50	add +40 dB to reading

## Operation

NOTE: The maximum voltage ratio that can be measured is +50 dB on the 0-250V range.

- e. If dB measurements are being made to a 0.006 watt into 500 ohm reference level, subtract +7 dB from the reading obtained on the 260.

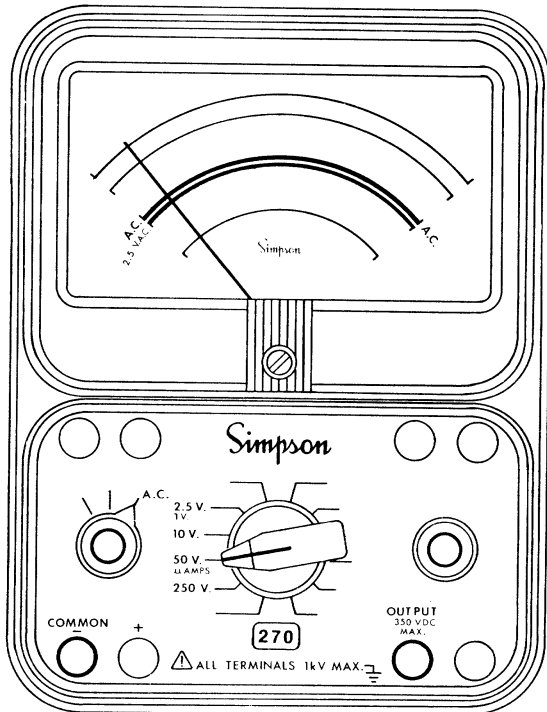

FIGURE 4-5. JACKS AND SWITCH POSITIONS FOR OUTPUT MEASUREMENT

## Operation

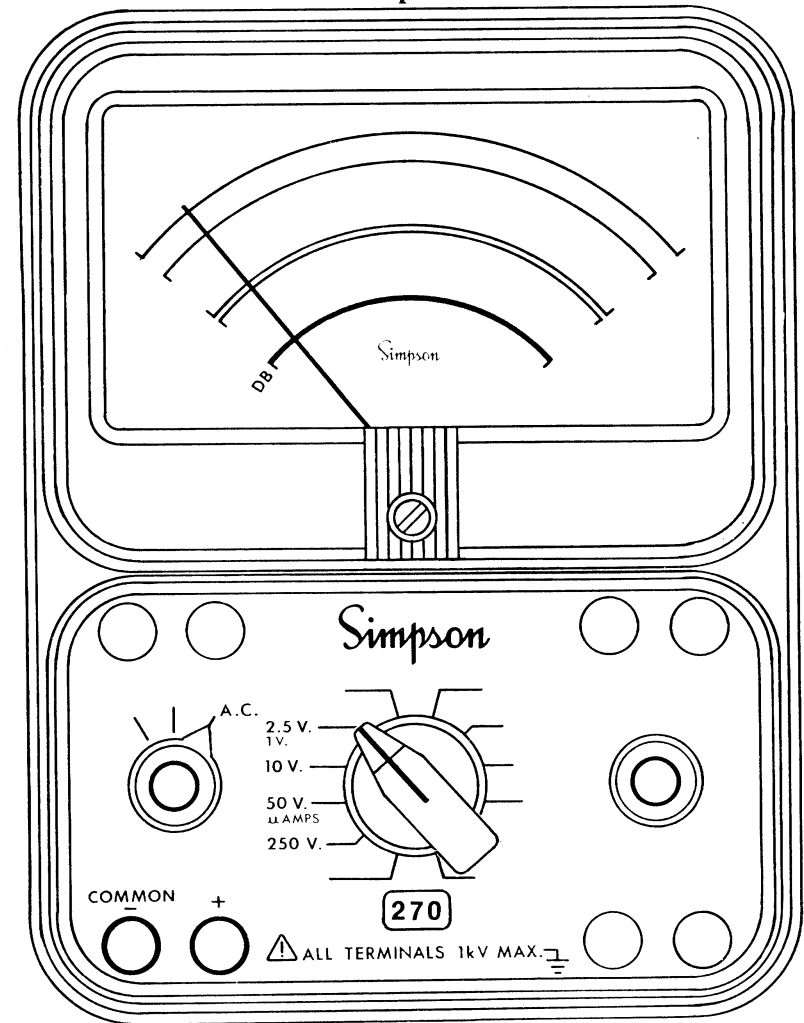

FIGURE 4-6. JACKS AND SWITCH POSITIONS FOR MEASURING DECIBELS

## Operation

### 4.14 DIRECT CURRENT MEASUREMENT

#### WARNING

- DO NOT CHANGE THE RANGE SETTING OF THE RANGE OR FUNCTION SWITCHES WHILE THE CIRCUIT UNDER MEASUREMENT IS ENERGIZED.
- NEVER DISCONNECT THE TEST LEADS FROM THE CIRCUIT UNDER MEASUREMENT WHILE THE CIRCUIT IS ENERGIZED.
- ALWAYS TURN THE CIRCUIT POWER OFF AND DISCHARGE ALL THE CAPACITORS BEFORE SETTING THE SWITCHES OR DISCONNECTING THE LEADS.
- NEVER EXCEED THE CIRCUIT-TO-GROUND VOLTAGE OF THE INSTRUMENT (1000 V MAX., TABLE 1-1, ITEM 16).
- ALWAYS CONNECT THE INSTRUMENT IN SERIES WITH THE GROUND SIDE OF THE CIRCUIT.

### 4.15 DIRECT CURRENT MEASUREMENT 0-50 $\mu$ A RANGE

- Set the function switch at +DC.
- Plug the black test lead into the - COMMON jack and the red test lead into the +50 $\mu$ AMPS/250mV jack.
- Set the range switch at 50 $\mu$ AMPS (dual position with 50V).
- Turn power OFF. Then discharge any capacitors in the circuit.
- Open the ground side of the circuit in which the current is being measured. Connect the VOM in series with the circuit. Connect the red test lead to the positive side and the black test lead to the negative side.

## Operation

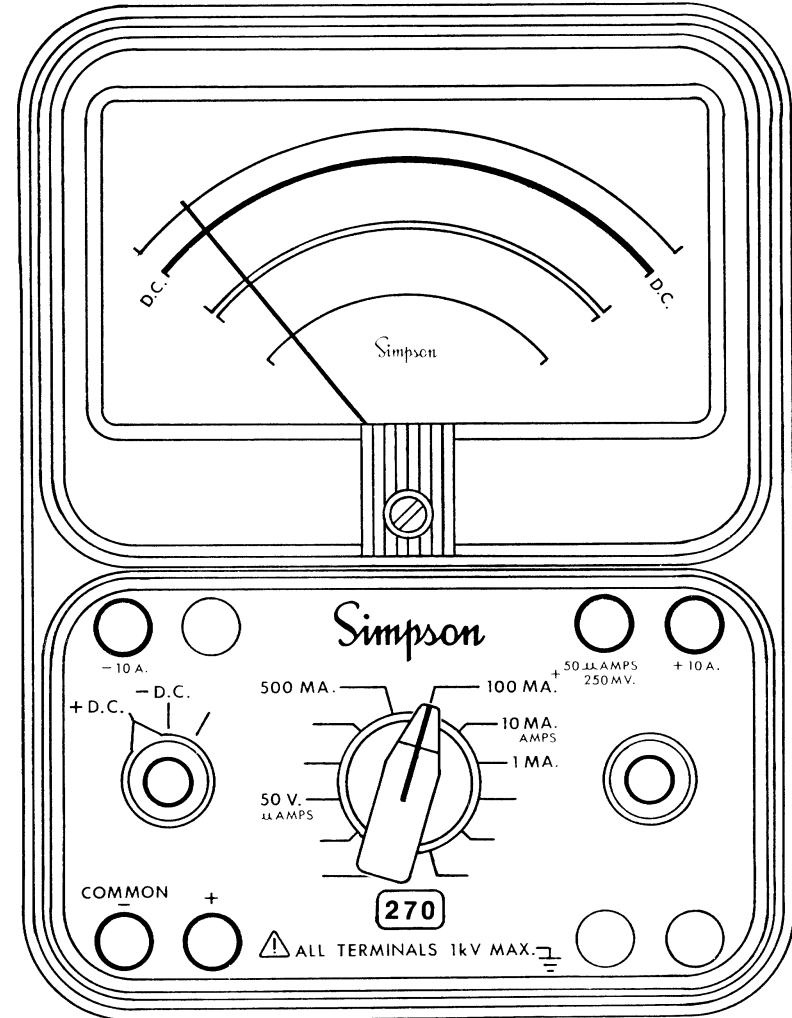

FIGURE 4-7. JACKS AND SWITCH POSITIONS FOR MEASURING DIRECT CURRENT

## Operation

- f. Turn power ON.
- g. Read the current on the black DC scale. Use the 0-50 figures to read directly in microamperes.
- h. Turn power OFF and restore circuit to original condition.

**NOTE: For polarity reversing see paragraph 4.3.**

### 4.16 DIRECT CURRENT MEASUREMENT 0-1mA THROUGH 0-500mA RANGE

- a. Set the function switch at +DC (Figure 4-7).
- b. Plug the black test lead into the – COMMON jack and the red test lead into the + jack.
- c. Set the range switch at one of the four range positions marked 1 mA, 10 mA, 100 mA or 500 mA.
- d. Turn power OFF. Then discharge any capacitors in the circuit.
- e. Open the grounded side of the circuit in which the current is being measured. Connect the VOM in series with the circuit. Connect the red test lead to the positive side and the black test lead to the negative side.
- f. Turn the power on. Read the current in milliamperes on the black DC scale. For the 1mA range, use the 0-10 figures and divide by 10. For the 10mA range, use the 0-10 figures directly. For the 100mA range, use the 0-10 figures and multiply by 10. For the 500mA range, use the 0-50 figures and multiply by 10.
- g. Turn the power off and disconnect the test leads.
- h. Restore circuit to original condition.

## Operation

### 4.17 DIRECT CURRENT MEASUREMENT 0-10A RANGE

- a. Plug the black test lead into the -10A jack and the red test lead into the +10A jack.
- b. Set the range switch at 10 AMPS (dual position with 10mA).
- c. Turn power OFF. Then discharge any capacitors in the circuit.
- d. Open the ground side of the circuit in which the current is being measured. Connect the VOM in series with the circuit. Connect the red test lead to the positive side and the black test lead to the negative side.

**NOTE:** The function switch has no effect on polarity for the 10 AMPS range.

- e. Turn the power on. Read the current directly on the black DC scale. Use the 0-10 figures to read directly in amperes.
- f. Turn the power off and disconnect the test leads.
- g. Restore circuit to original condition.

**CAUTION**

- **The 10A range is not internally fused in the 270.**
- **When using the 10A range, never disconnect a test lead from a jack or from the circuit while the circuit is energized. Doing so may likely damage the test jacks or leads and the arcing may be hazardous to the operator. Turn off circuit power and wait for the meter reading to drop to zero.**
- **The polarity reversing feature of the function switch does not operate on the 0-10A range. If polarity is found to be incorrect, turn off circuit power, wait for the meter indication to reach zero and then interchange test lead connections to the circuit.**

## Operation

### 4.18 RESISTANCE MEASUREMENTS

#### CAUTION

- Voltage applied to a resistance range will cause reading errors if low and damage the Instrument if high. When making in-circuit measurements, make certain that the circuit is completely deenergized before making connections to it.
- When making in-circuit measurements, circuit paths in parallel with the resistance being measured may cause reading errors. Check circuit diagrams for the presence of such components before assuming that the reading obtained is correct.

**4.18.1** When resistance is measured, the INTERNAL batteries B1 and B2 furnish power for the circuit. Since batteries are subject to variation in voltage and internal resistance, the Instrument must be adjusted to zero before measuring a resistance, as follows:

- Turn range switch to desired ohms range.
- Plug the black test lead into the – COMMON jack and the red test lead into the + jack.
- Connect ends of test leads together to short the VOM resistance circuit.
- Rotate the ZERO OHMS control until pointer indicates zero ohms. If pointer cannot be adjusted to zero, one or both of the batteries must be replaced. (For battery replacement, refer to Section V.)
- Disconnect shorted ends of test leads.

### 4.19 MEASURING RESISTANCE

- Before measuring resistance in the circuit make sure the power is off in the circuit being tested and all capacitors discharged.

## Operation

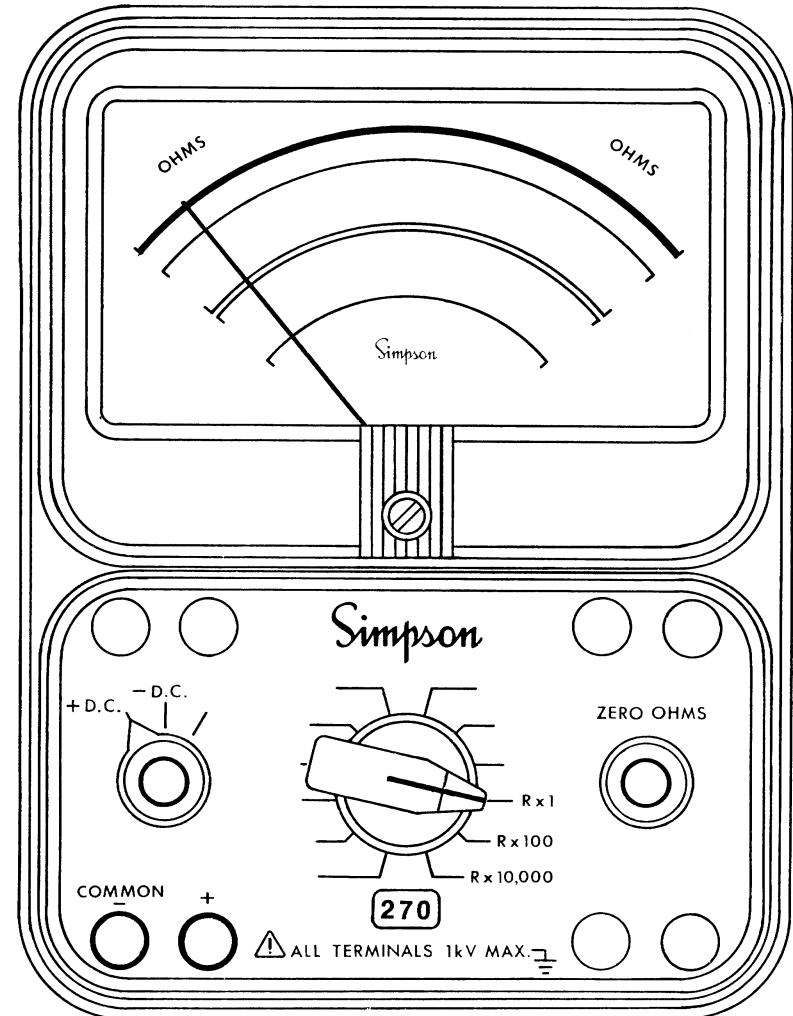

FIGURE 4-8. JACKS AND SWITCH POSITIONS FOR MEASURING RESISTANCE



## Operation

- b. Disconnect the shunted component from the circuit before measuring its resistance. Then set the range switch to one of the resistance range positions as follows (Figure 4-8):
  1. Use  $R \times 1$  for resistance readings from 0 to 200 ohms.
  2. Use  $R \times 100$  for resistance readings from 200 to 20,000 ohms.
  3. Use  $R \times 10,000$  for resistance readings above 20,000 ohms.
- c. Set the function switch at either -DC or +DC position: Operation is the same in either position except if there are semiconductors in the circuit. (See Paragraph 4.20.1) Adjust ZERO OHMS control for each resistance range.
- d. Observe the reading on the OHMS scale at the top of the dial. *Note: The OHMS scale reads from right to left for increasing values of resistance.*
- e. To determine the actual resistance value, multiply the reading by the factor at the switch position. (K on the OHMS scale equals one thousand.)

### 4.20 RESISTANCE MEASUREMENT OF SEMICONDUCTORS

CAUTION

**Make sure that the OHMS range being used will not damage any of the semiconductors (refer to Table 1-1, item 8, Section I).**

**4.20.1** If there is a "forward" and "backward" resistance such as in diodes, the resistance should be relatively low in one direction (for forward polarity) and higher in the opposite direction.

## Operation

Rotate the function switch between the two DC positions to reverse polarity. This will determine if there is a difference between the resistance in the two directions. To check a semiconductor in or out of a circuit (forward and reverse bias resistance measurements) consider the following *before* making the measurement:

- a. The polarity of the internal ohmmeter battery voltage at the (+) pos jack is identical to the function switch, polarity setting, and opposite to the (—) common jack.

CAUTION

**Make sure that the OHMS range being used will not damage any of the semiconductors (refer to Table 1-1, item 8, Section I).**

- b. If the semiconductor is a silicon diode or conventional silicon transistor, no precautions are normally required.
- c. If the semiconductor material is germanium, check the ratings of the device and refer to Table 1-1, item 8.

**NOTE:** The resistance of diodes will measure differently from one resistance range to another on the same VOM with the function switch in a given position. For example, a diode which measures 80 ohms on the  $R \times 1$  range may measure 300 ohms on the  $R \times 100$  range. The difference in values is a result of the diode characteristics and is not indicative of any fault in the VOM.

## SECTION V OPERATOR SERVICING

### Operator Servicing

#### 5.1 GENERAL

**5.1.1** The following paragraphs of this section describe the battery replacement, fuse replacement, test lead inspection and care for the 270-5.

#### 5.2 INSPECTION

**5.2.1** The user is protected from electrical shock by the insulation of the 270 and its test leads. Frequently examine them for any insulation damage such as cracks, cuts, chips, burns or deterioration that expose internal metal parts or reduce the spacing between such metal parts and hand contact by the operator.

**5.2.2** Make certain that the battery compartment cover is securely fastened in place before the Instrument is used.

**5.2.3** Do not permit an instrument with a broken glass meter cover to be used.

**5.2.4** Whenever the battery compartment cover is removed for any reason, check that the proper fuses are being used.

**5.2.5** Severe overloads may have damaged the Instruments circuitry despite the protection afforded by the fuse. When a fuse is replaced, all ranges should be routinely checked (calibrated) against the specifications in this manual before the Instrument is returned to service.

#### 5.3 BATTERY REPLACEMENT:

a. Two batteries are used inside the case to supply power for resistance measurements. One is a 1.5-volt D battery and the other is a 9-volt battery. When it is no longer possible to adjust

the pointer to zero for the R X 1 and R X 100 ranges (refer to ZERO OHMS ADJUSTMENT paragraph 4.19) replace the 1.5-volt cell. When it is no longer possible to adjust the pointer to zero on the R X 10,000 range, replace the 9-volt battery.

- b. Recommended replacement batteries are:  
1.5 volt D, NEDA 13F (Burgess No. 2 Eveready No. 950).  
9-volt battery, NEDA 1604 (Burgess 2U6 or Eveready 216).
- c. To install or replace a battery, de-energize and disconnect test leads from the Instrument, then remove the cover to the externally accessible battery compartment by loosening the single captivated screw.

NOTE: Batteries should be replaced before their useful life has expired. Failure to do so may result in battery leakage and corrosion.

- d. Observe polarity when replacing the 1.5-volt D battery and connect as indicated. The D battery is held in place with spring clips which also act as battery contact clips. The 9-volt battery contacts and connector are polarized. To remove the 9-volt battery, first withdraw battery with mated connector from the compartment. Then remove the connector.

#### 5.4 FUSE REPLACEMENT

**5.4.1** The 1 and 2 ampere fuse (also the 1A spare) is located in the externally accessible battery and fuse compartment. Access to the compartment is obtained by de-energizing and disconnecting the test leads and loosening the single captivated screw on the compartment cover. To replace or check a fuse: Apply pressure to the 1 amp fuse cup then rotate the plate to expose a selected fuse for removal from the panel's cavity.

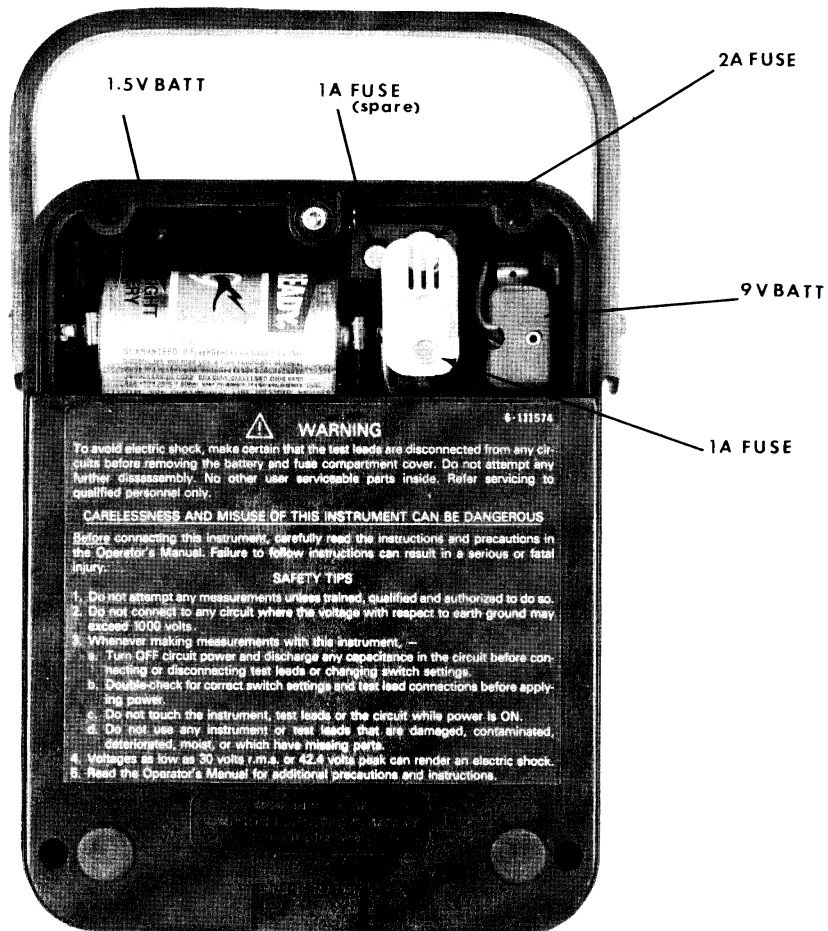

FIGURE 5-1. BATTERY AND FUSE COMPARTMENT

**NOTE:** It is important to replace the 1 and 2 ampere fuse with the specified fuse type only. (See replacement parts list, Table 6-1, for proper fuse type.)

## 5.5 TEST LEAD INSPECTION

**5.5.1** Periodic inspection of the test leads is recommended to detect cuts, burned areas, deterioration or other damage that could reduce the insulation strength of the leads.

### WARNING

**Before returning the Instrument to service, check the performance and make sure that the electrical and mechanical configurations have been restored to their original ratings and condition.**

## 5.6 CARE

**5.6.1** Immediately clean all spilled materials from the Instrument and wipe dry. If the spillage is corrosive, use a suitable cleaner to neutralize the corrosive action, and remove the spillage.

**5.6.2** Whenever the Instrument is not in use, rotate the function switch to the OFF/TRANSIT position.

**5.6.3** Whenever possible, avoid prolonged exposure or usage in areas which are subject to temperature and humidity extremes, vibration or mechanical shock, dust or corrosive fumes, or strong electrical or electromagnetic fields.

**5.6.4 Monthly Care:** Verify Instrument accuracy by performing operational checks using known, accurate, stable sources. If proper calibration equipment is not available, contact the nearest

## Operator Servicing

Authorized Service Center (refer to last pages of this manual). If the Instrument has not been used for 30 days, check the batteries for leakage and replace if necessary.

**5.6.5 Annual Care:** It is recommended that the Instrument be returned annually to the nearest Authorized Service Center, or to the factory, for an overall check, adjustment, and calibration.

**5.6.6 Storage:** When the Instrument is not in use, store it in a room free from temperature extremes, dust, corrosive fumes, and mechanical vibration or shock. If storage time is expected to exceed 30 days, remove batteries.

**WARNING**

**The following Servicing Instructions are for use by qualified personnel only. To avoid electrical shock, do not perform any servicing other than that contained in the operating instructions unless you are qualified to do so.**

---

Courtesy of :  
Simpson260.com

## SECTION VI SERVICING INSTRUCTIONS

### Replacement Parts

#### 6.1 GENERAL

**NOTE:** This instrument must be serviced by qualified personnel. To aid in troubleshooting a schematic diagram is enclosed. The replacement parts list (Table 6-1) describes the components and refers to Simpson part numbers. Reference Symbol numbers correlate the components shown on the schematic diagram with the parts list.

**6.1.1** The following information is provided as an adjunct to the overall text contained in this manual and should be read and understood thoroughly prior to ordering replacement parts for the Instrument.

#### 6.2 REMOVING THE INSTRUMENT CASE

**6.2.1** To gain access to the inside of the Instrument panel, first; de-energize and disconnect the test leads, and remove the cover from the battery compartment, then remove the four case-fastening screws. Second; after removing the screws, lift the case from the panel.

**NOTE:** When replacing the case, make certain that the wires leading to the battery compartment are seated in their respective slots within the compartment wall. This will prevent damage to the wire insulation during mating of panel and case.

#### 6.3 REPLACEMENT PARTS AND SCHEMATIC DIAGRAM

**6.3.1** To obtain replacement parts, address order to the nearest Authorized Service Center (listed on the last pages of this manual). Refer to paragraph 2.3.1 for ordering instructions.

TABLE 6-1. REPLACEMENT PARTS

Reference Symbol	Description	Part No.
R1	Rheostat, 150 k $\Omega$	6-111487
R1A	Resistor, 20 k $\Omega$	5-119705
R2, R22,		
R25	Rheostat, 3 k $\Omega$	6-111488
R2A	Resistor, 2.2 k $\Omega$	5-118606
R3	Resistor, 15 k $\Omega$	5-115082
R4	Resistor, 45 k $\Omega$	1-117148
R5	Resistor, 150 k $\Omega$	1-117149
R6	Resistor, 800 k $\Omega$	1-117147
R7	Resistor, 4 M $\Omega$	1-117151
R8	Resistor, 5 M $\Omega$	1-118181
R9	Resistor, 7.5 M $\Omega$	5-115081
R10	Resistor, 2.5 M $k\Omega$	5-115080
R11	Resistor, 0.025 $\Omega$ Shunt, 10A (Calibrate in Instrument)	6-111575
R12	Resistor, 0.47 $\Omega$ 5W (Wire Wound)	6-111980
R13	Resistor, 2 $\Omega$ 5W (Wire Wound)	6-111810
R14	Resistor, 22.5 $\Omega$ 3W (Wire Wound)	6-111809
R15	Resistor, 238 $\Omega$	1-115079
R16	Resistor, 11 $\Omega$ , 5W (Wire Wound)	6-111979
R17	Resistor, 1.095 k $\Omega$	6-111639
R18	Resistor, 138 $\Omega$	6-111640
R19	Resistor, 17.320 k $\Omega$	6-111638
R20	Resistor, 113.860 k $\Omega$	6-111637
R21	Potentiometer, 11.25 k $\Omega$	6-111446
R23, R24	Resistor, 4 k $\Omega$	1-117140

## Replacement Parts

R26	Resistor, 7.5 k $\Omega$	1-117152
R27	Resistor, 37.5 k $\Omega$	1-117145
R28	Resistor, 200 k $\Omega$	1-117146
R29	Resistor, 1 M $\Omega$	1-117150
R30	Resistor, 1.25 M $\Omega$	5-110455
C1	Capacitor, 0.1 $\mu$ F, 400 V	1-113733
D1, D2	Diode, Germanium	1-115970
V1	Varistor, Silicon	1-110670
F1	Fuse, 1 Amp, 250V; 3AG (1 $\frac{1}{4}$ " x $\frac{1}{4}$ " Quick acting (Littelfuse Type 312001)	1-112507
F2	Fuse, 2A, 600 V (Bussman Type BBS or Littelfuse Type BLS)	5-119056
	For Function Switch	1-115789
F1	Knobs: For Zero Ohms Adjust	1-115790
	For Range Switch	10-864352
	Case Assembly, Phenolic, Complete, (including handle less Battery Compart- ment Cover)	10-861725
	Battery Compartment Cover Assembly	10-861724
	Rubber Bumper Plug	5-115039
	270-5 and 270-5RT Indicating Instrument with Panel Assembly	D-13824
	Cover Assembly for Indicating Instrument	10-560288
	Probe Tip Leads, one red and one black	00043
	Label, Battery and Fuse Data	6-111489
	Label, Warning	6-111574



## NOTES

*FOR THE RECORD*

*Date Purchased* \_\_\_\_\_

*Purchased From:* \_\_\_\_\_

*Identification Number:* \_\_\_\_\_

<i>Date</i>	<i>Type of Service</i>	<i>Serviced By</i>
_____	_____	_____
_____	_____	_____
_____	_____	_____
_____	_____	_____
_____	_____	_____
_____	_____	_____
_____	_____	_____
_____	_____	_____

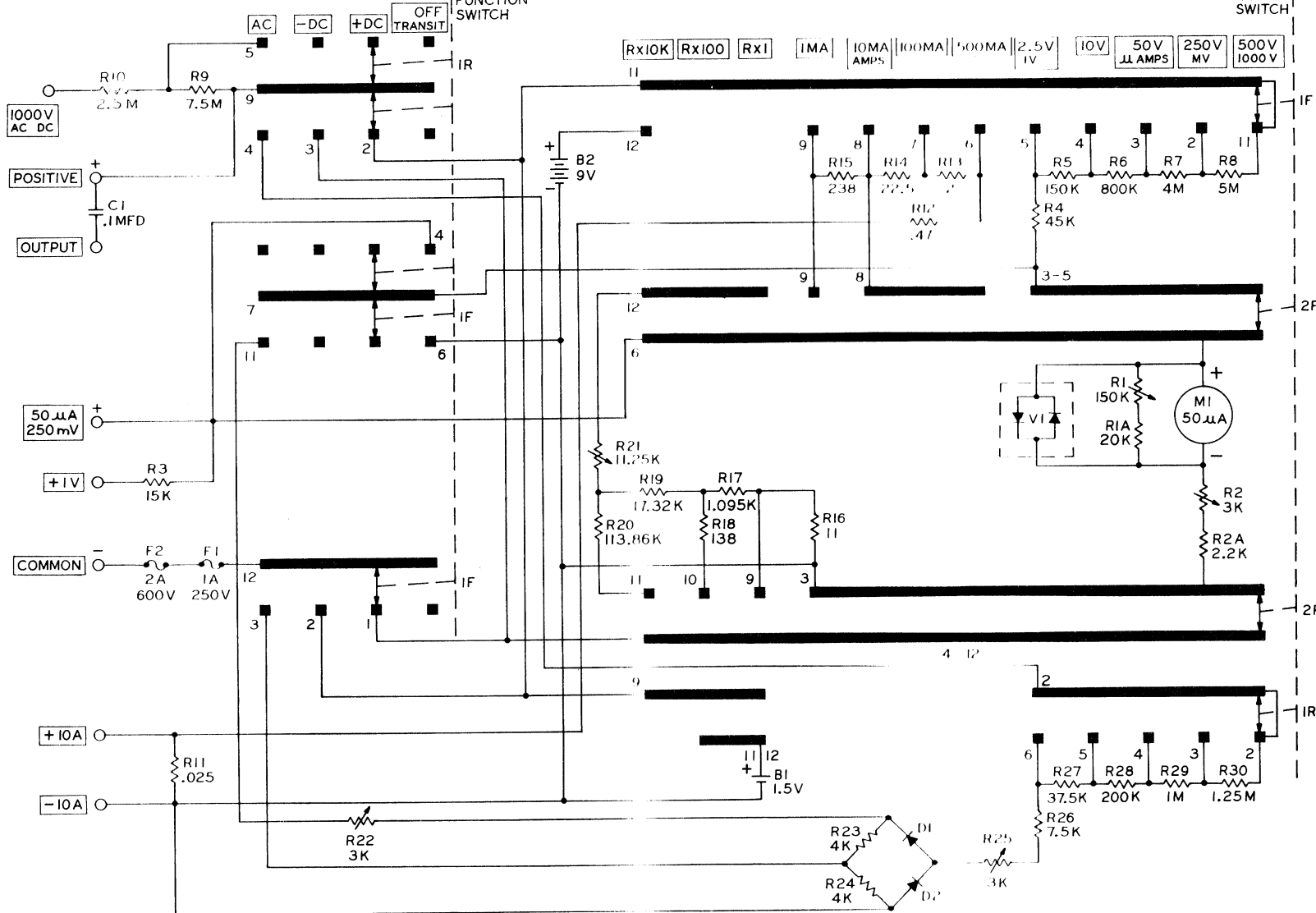

**NOTES:**

1. UNLESS OTHERWISE SPECIFIED; RESISTORS IN OHMS, CAPACITORS IN µF.
2. RANGE SWITCH IS IN 500/1000V POSITION. FUNCTION SWITCH IS IN +DC POSITION.
3.  DENOTES FRONT PANEL GRAPHICS.